

SAMSUNG

TFT-LCD TV/MONITOR

Chassis
VR22UO

Model
LTP227W

SERVICE *Manual*

TFT-LCD TV/MONITOR



CONTENTS

1. Precautions
2. Product Specifications
3. Disassembly & Reassembly
4. Alignment & Adjustments
5. Troubleshooting
6. Exploded View & Parts List
7. Parts List
8. Block Diagram
9. Wiring Diagram
10. PCB Layout
11. Schematic Diagrams
12. Panel Description



Samsung Electronics Co.,Ltd.

416, Maetan-3Dong, Yeongtong-Gu, Suwon City, Kyungki-Do, Korea, 442-742

Printed in Korea

P/N : BN82-00103E-00

[http : //www.samsungmonitor.com](http://www.samsungmonitor.com) (SyncMaster Worldwide)

[http : //www.samsung-monitor.com](http://www.samsung-monitor.com) (SyncMaster USA)

URL : <http://itself.sec.samsung.co.kr/>

* This Service Manual is a property of Samsung Electronics Co., Ltd.
Any unauthorized use of Manual can be punished under applicable International and/or domestic law.

1 Precautions

Follow these safety, servicing and ESD precautions to prevent damage and to protect against potential hazards such as electrical shock.

1-1 Safety Precautions

1-1-1 Warnings

1. For continued safety, do not attempt to modify the circuit board.
2. Disconnect the AC power and DC Power Jack before servicing.

1-1-2 Servicing the LCD Monitor

1. When servicing the LCD Monitor Disconnect the AC line cord from the AC outlet.
2. It is essential that service technicians have an accurate voltage meter available at all times. Check the calibration of this meter periodically.

1-1-3 Fire and Shock Hazard

Before returning the monitor to the user, perform the following safety checks:

1. Inspect each lead dress to make certain that the leads are not pinched or that hardware is not lodged between the chassis and other metal parts in the monitor.
2. Inspect all protective devices such as nonmetallic control knobs, insulating materials, cabinet backs, adjustment and compartment covers or shields, isolation resistor-capacitor networks, mechanical insulators, etc.
3. Leakage Current Hot Check (Figure 1-1):

WARNING: Do not use an isolation transformer during this test.

Use a leakage current tester or a metering system that complies with American National Standards Institute (ANSI C101.1, *Leakage Current for Appliances*), and Underwriters Laboratories (UL Publication UL1410, 59.7).

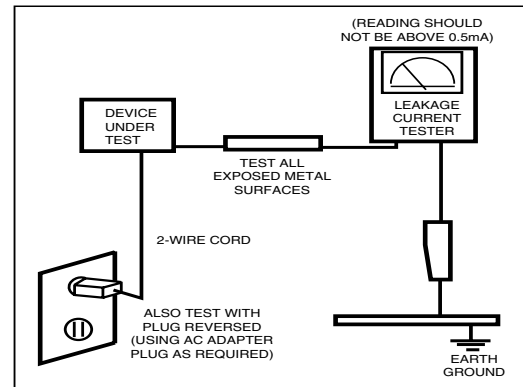

Figure 1-1. Leakage Current Test Circuit

4. With the unit completely reassembled, plug the AC line cord directly into a 120V AC outlet. With the unit's AC switch first in the ON position and then OFF, measure the current between a known earth ground (metal water pipe, conduit, etc.) and all exposed metal parts, including: metal cabinets, screwheads and control shafts. The current measured should not exceed 0.5 milliamp. Reverse the power-plug prongs in the AC outlet and repeat the test.

1-1-4 Product Safety Notices

Some electrical and mechanical parts have special safety-related characteristics which are often not evident from visual inspection. The protection they give may not be obtained by replacing them with components rated for higher voltage, wattage, etc. Parts that have special safety characteristics are identified by ⚠ on schematics and parts lists. A substitute replacement that does not have the same safety characteristics as the recommended replacement part might create shock, fire and/or other hazards. Product safety is under review continuously and new instructions are issued whenever appropriate.

1-2 Servicing Precautions

WARNING: An electrolytic capacitor installed with the wrong polarity might explode.

Caution: Before servicing units covered by this service manual, read and follow the Safety Precautions section of this manual.

Note: If unforeseen circumstances create conflict between the following servicing precautions and any of the safety precautions, always follow the safety precautions.

1-2-1 General Servicing Precautions

1. Always unplug the unit's AC power cord from the AC power source and disconnect the DC Power Jack before attempting to:
 - (a) remove or reinstall any component or assembly,
 - (b) disconnect PCB plugs or connectors, (c) connect a test component in parallel with an electrolytic capacitor.
2. Some components are raised above the printed circuit board for safety. An insulation tube or tape is sometimes used. The internal wiring is sometimes clamped to prevent contact with thermally hot components. Reinstall all such elements to their original position.
3. After servicing, always check that the screws, components and wiring have been correctly reinstalled. Make sure that the area around the serviced part has not been damaged.
4. Check the insulation between the blades of the AC plug and accessible conductive parts (examples: metal panels, input terminals and earphone jacks).
5. Insulation Checking Procedure: Disconnect the power cord from the AC source and turn the power switch ON. Connect an insulation resistance meter (500 V) to the blades of the AC plug.
The insulation resistance between each blade of the AC plug and accessible conductive parts (see above) should be greater than 1 megohm.
6. Always connect a test instrument's ground lead to the instrument chassis ground before connecting the positive lead; always remove the instrument's ground lead last.

1-3 Electrostatically Sensitive Devices (ESD) Precautions

Some semiconductor (solid state) devices can be easily damaged by static electricity. Such components are commonly called Electrostatically Sensitive Devices (ESD). Examples of typical ESD are integrated circuits and some field-effect transistors. The following techniques will reduce the incidence of component damage caused by static electricity.

1. Immediately before handling any semiconductor components or assemblies, drain the electrostatic charge from your body by touching a known earth ground. Alternatively, wear a discharging wrist-strap device. To avoid a shock hazard, be sure to remove the wrist strap before applying power to the monitor.
2. After removing an ESD-equipped assembly, place it on a conductive surface such as aluminum foil to prevent accumulation of an electrostatic charge.
3. Do not use freon-propelled chemicals. These can generate electrical charges sufficient to damage ESDs.
4. Use only a grounded-tip soldering iron to solder or desolder ESDs.
5. Use only an anti-static solder removal device. Some solder removal devices not classified as "anti-static" can generate electrical charges sufficient to damage ESDs.
6. Do not remove a replacement ESD from its protective package until you are ready to install it. Most replacement ESDs are packaged with leads that are electrically shorted together by conductive foam, aluminum foil or other conductive materials.
7. Immediately before removing the protective material from the leads of a replacement ESD, touch the protective material to the chassis or circuit assembly into which the device will be installed.
Caution: Be sure no power is applied to the chassis or circuit and observe all other safety precautions.
8. Minimize body motions when handling unpackaged replacement ESDs. Motions such as brushing clothes together, or lifting your foot from a carpeted floor can generate enough static electricity to damage an ESD.

2 Product Specifications

2-1 Specifications

Item	Description	
LCD Panel	TFT-LCD Panel, RGB vertical stripe, normaly Black, 22-Inch viewable, 0.381 mm pixel pitch	
Scanning Frequency	Horizontal : 30 kHz ~ 68 kHz (Automatic) Vertical : 56 Hz ~ 85 Hz (Automatic)	
Display Colors	16.7 Million colors	
Maximum Resolution	Horizontal : 1280 Pixels Vertical : 720 Pixel	
Input Video Signal	Positive at 75 Ω	
Input Sync Signal	Type : Seperate H/V Level : TTL level	
Maximum Pixel Clock rate	70 MHz	
Active Display Horizontal/Vertical	487.68 mm/ 274.32 mm	
AC power voltage & Frequency	AC 100 ~ 264 Volts, 50~60 Hz \pm 3 Hz	
Power Consumption	80 W	
Dimensions (W x H x D) Set Package	23.6 x 17.3 x 8.2 Inches (599 X 439 X 209.4 mm) / 23.6 x 16.5 x 4.4 Inches (599 X 418 X 112.7 mm) State of stand disassembled 28.1 x 23.0 x 8.1 Inches (713.0 X 583.0 X 205.0 mm)	
Weight Set / Package	8.98 kg (19.8 lbs) After installation of Stand / 11.0 kg (24.3 lbs)	
Environmental Considerations	Operating Temperature : 50 °F ~ 104 °F (10 °C ~ 40 °C) Operating Humidity : 10 % ~ 80 % Storage Temperature : -4 °F ~ 113 °F (-20 °C ~ 45 °C) Storage Humidity : 5 % ~ 95 %	
TV System	Tunning	Frequency Synthesize
	System	NTSC-M
	Sound	STEREO
Antena Input	75 Ω	
Sound Characteristic	– MAX Internal speaker Out : Right => 5W Left => 5W	
	– BASS Control Range : -8 dB ~ + 8dB – TREBLE Control Range : -8 dB ~ +8 dB – Headphone Out : 5 mW max (400 m Vrms) – Output Frequency : 20 Hz ~15.2 Hz	

2-2 Pin Assignments

2-2-1 DVI-I (Analog & Digital)

Ref) DVI-D : Digital only

D-SUB : Analog only

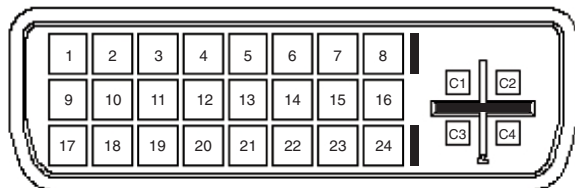

DVI-I Receptacle Connector Front View

Pin No.	Signal Assignment	Pin No.	Signal Assignment	Pin No.	Signal Assignment
1	RX2-	11	GND	21	NC
2	RX2+	12	NC	22	GND
3	GND	13	NC	23	RXC+
4	NC	14	DDC Input Power(+5V)	24	RXC-
5	NC	15	IDENT_PC	C1	Analog Red
6	DDC Clock (SCL)	16	5V	C2	Analog Green
7	DDC Data (SDA)	17	RX0-	C3	Analog Blue
8	Analog Vertical Sync.	18	RX0+	C4	Analog Horizontal Sync.
9	RX1-	19	GND		
10	RX1+	20	NC		

2-2-2 Component 1, 2

RCA Green	Y
	GND
RCA Blue	Pb (Cb)
	GND
RCA Red	Pr (Cr)
	GND
RCA White	Audio L
	GND
RCA Red	Audio R
	GND

2-2-3 S-Video

Pin	Separate
1	GND
2	Y
3	C
4	GND
5	GND

2-2-4 A/V

RCA Yellow	CVBS
RCA White	Audio L
	GND
RCA Red	Audio R
	GND

2-3 Timing Chart

This section of the service manual describes the timing that the computer industry recognizes as standard for computer-generated video signals.

2-3-1 LCD Panel Mode1 mode

Timing No.	
Originator	VESA DTV
Mode Name	1280/60Hz
Resolution (HxV)	1280x720
HORIZONTAL	
Frequency	45 kHz
Total time	22.200 μ s
Active time	17.239 μ s
Blank time	4.984 μ s
Border(L / R)	0.000 μ s
Data time	17.239 μ s
Front porch	0.943 μ s
Sync. width	0.539 μ s
Back porch	3.502 μ s
Sync. polarity	Negative
VERTICAL	
Frequency	60Hz
Total time	16.000 ms
Active time	16.000 ms
Blank time	1.222 ms
Border(T / B)	0.000 ms
Data time	16.000 ms
Front porch	0.667 ms
Sync. width	0.111 ms
Back porch	0.444 ms
Sync. polarity	Positive
Dot Clock	74.25 MHz
Sync. Type	Separate
Scan Type*	N/I

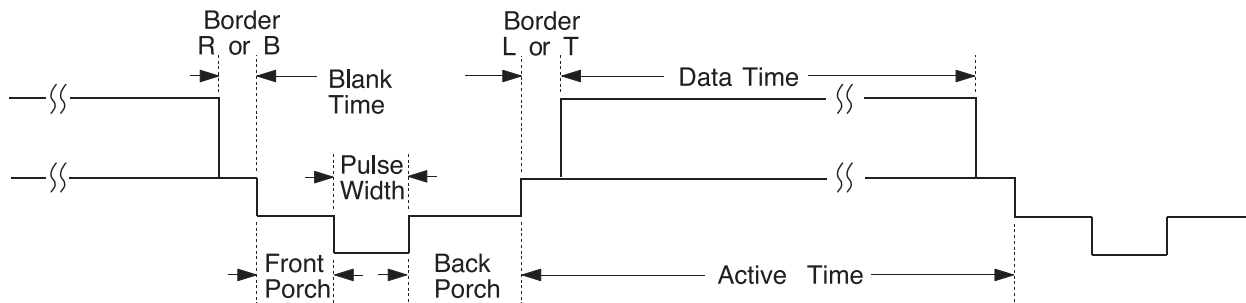

2-3-1 Supported Modes (1)

Timing No.	2	3	11	17	32	42
Originator	IBM	IBM	VESA	VESA	MAC	VESA
Mode Name	VGA2	VGA3	640/72Hz	640/75Hz	640/67Hz	640/85Hz
Resolution (HxV)	720x400	640x480	640x480	640x480	640x480	640x480
HORIZONTAL						
Frequency	31.469kHz	31.469kHz	37.861kHz	37.500kHz	35.000kHz	43.269kHz
Total time	31.777μs	31.778μs	26.413μs	26.667μs	28.571μs	23.111μs
Active time	26.058μs	26.058μs	20.825μs	20.317μs	21.164μs	17.778μs
Blank time	5.720μs	5.720μs	5.588μs	6.350μs	7.407μs	5.333μs
Border(L / R)	0.318μs	0.318μs	0.254μs	0.000μs	0.000μs	0.000μs
Data time	25.422μs	25.422μs	20.317μs	20.317μs	21.164μs	17.778μs
Front porch	0.318μs	0.318μs	0.508μs	0.508μs	2.116μs	1.556μs
Sync. width	3.813μs	3.813μs	1.270μs	2.032μs	2.116μs	1.556μs
Back porch	1.589μs	1.589μs	3.810μs	3.810μs	3.175μs	2.222μs
Sync. polarity	Negative	Negative	Negative	Negative	Negative	Negative
VERTICAL						
Frequency	70.087Hz	59.940Hz	72.809Hz	75.000Hz	66.667Hz	85.008Hz
Total time	14.268ms	16.683ms	13.735ms	13.333ms	15.000ms	11.764ms
Active time	13.155ms	15.761ms	13.100ms	12.800ms	13.714ms	11.093ms
Blank time	1.113ms	0.922ms	0.635ms	0.533ms	1.286ms	0.671ms
Border(T / B)	0.222ms	0.254ms	0.211ms	0.000ms	0.000ms	0.000ms
Data time	12.711ms	15.253ms	12.678ms	12.800ms	13.714ms	11.093ms
Front porch	0.191ms	0.064ms	0.026ms	0.027ms	0.086ms	0.023ms
Sync. width	0.064ms	0.064ms	0.079ms	0.080ms	0.086ms	0.069ms
Back porch	0.858ms	0.794ms	0.528ms	0.427ms	1.114ms	0.578ms
Sync polarity	Positive	Negative	Negative	Negative	Negative	Negative
Dot Clock	28.322MHz	25.175MHz	31.500MHz	31.500MHz	30.240MHz	36.000MHz
Sync. Type	Separate	Separate	Separate	Separate	Separate	Separate
Scan Type	N/I	N/I	N/I	N/I	N/I	N/I

2-3-1 Supported Modes (2)

Timing No.	12	13	14	18	43	33
Originator	VESA	VESA	VESA	VESA	VESA	MAC
Mode Name	800/56Hz	800/60Hz	800/72Hz	800/75Hz	800/85Hz	832/75Hz
Resolution (HxV)	800x600	800x600	800x600	800x600	800x600	832x624
HORIZONTAL						
Frequency	35.156kHz	37.879kHz	48.077kHz	46.875kHz	53.674kHz	49.726kHz
Total time	28.444 μ s	26.400 μ s	20.800 μ s	21.333 μ s	18.631 μ s	20.110 μ s
Active time	22.222 μ s	20.000 μ s	16.000 μ s	16.162 μ s	14.222 μ s	14.524 μ s
Blank time	6.222 μ s	6.400 μ s	4.800 μ s	5.171 μ s	4.409 μ s	5.586 μ s
Border(L / R)	0.000 μ s	0.000 μ s	0.000 μ s	0.000 μ s	0.000 μ s	0.000 μ s
Data time	22.222 μ s	20.000 μ s	16.000 μ s	16.162 μ s	14.222 μ s	14.524 μ s
Front porch	0.667 μ s	1.000 μ s	1.120 μ s	0.323 μ s	0.569 μ s	0.559 μ s
Sync. width	2.000 μ s	3.200 μ s	2.400 μ s	1.616 μ s	1.138 μ s	1.117 μ s
Back porch	3.556 μ s	2.200 μ s	1.280 μ s	3.232 μ s	2.702 μ s	3.910 μ s
Sync. polarity	Positive or Negative	Positive	Positive	Positive	Positive	Negative
VERTICAL						
Frequency	56.250Hz	60.317Hz	72.188Hz	75.000Hz	85.061Hz	74.551Hz
Total time	17.778ms	16.579ms	13.853ms	13.333ms	11.756ms	13.414ms
Active time	17.067ms	15.840ms	12.480ms	12.800ms	11.179ms	12.549ms
Blank time	0.711ms	0.739ms	1.373ms	0.533ms	0.577ms	0.865ms
Border(T / B)	0.000ms	0.000ms	0.000ms	0.000ms	0.000ms	0.000ms
Data time	17.067ms	15.840ms	12.480ms	12.800ms	11.179ms	12.549ms
Front porch	0.028ms	0.026ms	0.770ms	0.021ms	0.019ms	0.020ms
Sync. width	0.057ms	0.106ms	0.125ms	0.064ms	0.056ms	0.060ms
Back porch	0.626ms	0.607ms	0.478ms	0.448ms	0.503ms	0.784ms
Sync polarity	Positive or Negative	Positive	Positive	Positive	Positive	Negative
Dot Clock	36.000MHz	40.000MHz	50.000MHz	49.500MHz	56.250MHz	57.284MHz
Sync. Type	Separate	Separate	Separate	Separate	Separate	Separate Composite Sync.- on-G
Scan Type	N/I	N/I	N/I	N/I	N/I	N/I

2-3-1 Supported Modes (3)

Timing No.	15	16	19	44
Originator	VESA	VESA	VESA	VESA
Mode Name	1024/60Hz	1024/70Hz	1024/75Hz	1024/85Hz
Resolution (HxV)	1024x768	1024x768	1024x768	1024x768
HORIZONTAL				
Frequency	48.363kHz	56.476kHz	60.023kHz	68.677kHz
Total time	20.677 μ s	17.707 μ s	16.660 μ s	14.561 μ s
Activetime	15.754 μ s	13.653 μ s	13.003 μ s	10.836 μ s
Blank time	4.923 μ s	4.053 μ s	3.777 μ s	3.725 μ s
Border(L / R)	0.000 μ s	0.000 μ s	0.000 μ s	0.000 μ s
Data time	15.754 μ s	13.653 μ s	13.003 μ s	10.836 μ s
Front porch	0.369 μ s	0.320 μ s	0.323 μ s	0.508 μ s
Sync. width	2.092 μ s	1.813 μ s	1.219 μ s	1.016 μ s
Back porch	2.462 μ s	1.920 μ s	2.235 μ s	2.201 μ s
Sync. polarity	Negative	Negative	Positive	Positive
VERTICAL				
Frequency	60.004Hz	70.069Hz	75.029Hz	84.997Hz
Total time	16.666ms	14.272ms	13.328ms	11.765ms
Active time	15.880ms	13.599ms	12.795ms	11.183ms
Blank time	0.786ms	0.672ms	0.533ms	0.582ms
Border(T / B)	0.000ms	0.000ms	0.000ms	0.000ms
Data time	15.880ms	13.599ms	12.795ms	11.183ms
Front porch	0.062ms	0.053ms	0.017ms	0.015ms
Sync. width	0.124ms	0.106ms	0.050ms	0.044ms
Back porch	0.600ms	0.513ms	0.466ms	0.524ms
Sync polarity	Negative	Negative	Positive	Positive
Dot Clock	65.000MHz	75.000MHz	78.750MHz	94.500MHz
Sync. Type	Separate	Separate	Separate	Separate
Scan Type [*]	N/I	N/I	N/I	N/I

Memo

3 Disassembly and Reassembly

This section of the service manual describes the disassembly and reassembly procedures for the LTP227W monitor.

WARNING: This monitor contains electrostatically sensitive devices. Use caution when handling these components.

3-1 Disassembly

- Cautions :**
1. Disconnect the monitor from the power source before disassembly.
 2. Follow these directions carefully; never use metal instruments to pry apart the cabinet.
 3. R/Cover opening jig : BH81-00001A



1. Loacte the monitor on the cushioned table with face down. Remove the stand from LCD-TV and pull the stand cover.

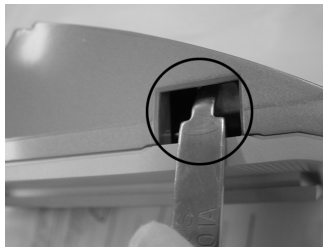

2. Remove 2 screws from the rear cover and remove rear cover by using opening jig.

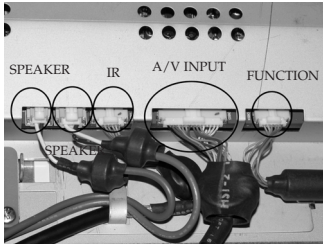
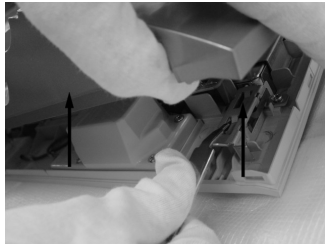

3. Lift up the rear cover and disconnect function cable, A/V Input cable, IR cable and speaker cable from the shield. (See illustrations)

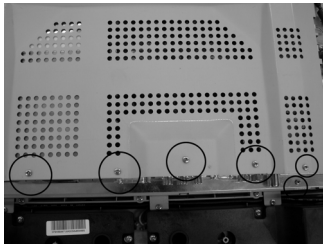
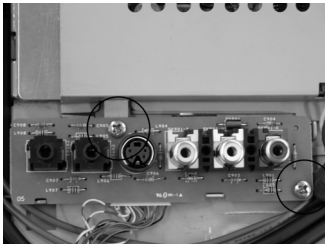

4. Remove 2 screws (A/V Input Board) from the shield. Please add a circle around the 6 screw that connects the silver shield of the Main-PCB to the Panel shield.(see illustrations)

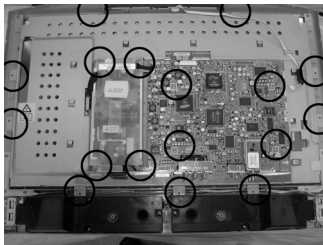
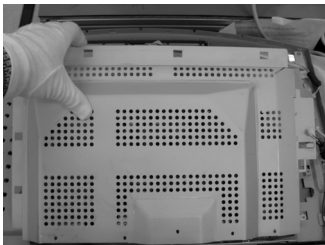

5. Lift up main shield and remove 17 screws from the set (Main Board and Panel Shield). (see illustrations)

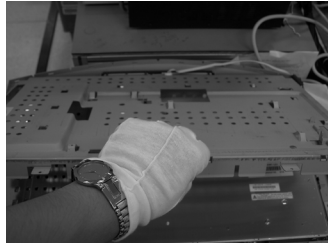
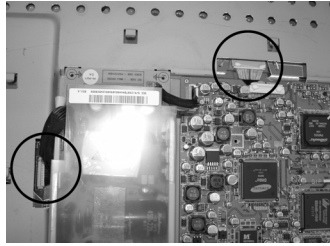

6. Disconnect cable and lift up the main board and panel shield. (see illustrations)

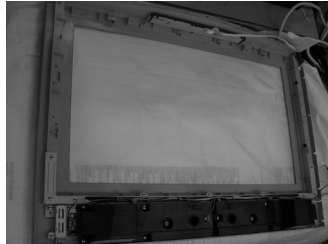
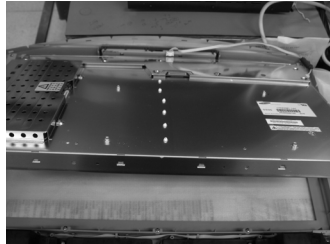

7. Lift up the panel.

3-2 Replacement Order of Lamp Assemblies

LCD panel may not be serviced. (Lamps are generally located at top and bottom of panel, which may be replaced. However, for the Victoria LTA170WP_L01 panel, the lamp is firmly soldered inside of the back panel. Therefore, servicing the lamp may cause a defective panel. Also, servicing lamp requires front glass removal, which may cause scratch and/or foreign materials on the glass.)

3-3 Reassembly

Reassembly procedures are in the reverse order of disassembly procedures.

4 Alignments and Adjustments

4-1 General Alignment Instruction

1. Usually, a color TV-VCR needs only slight touch-up adjustment upon installation. Check the basic characteristics such as height, horizontal and vertical sync.
2. Use the specified test equipment or its equivalent.
3. Correct impedance matching is essential.
4. Avoid overload. Excessive signal from a sweep generator might overload the front-end of the TV. When inserting signal markers, do not allow the marker generator to distort test result.
5. Connect the TV only to an AC power source with voltage and frequency as specified on the backcover nameplate.
6. Do not attempt to connect or disconnect any wire while the TV is turned on. Make sure that the power cord is disconnected before replacing any parts.
7. To protect against shock hazard, use an isolation transform.

4-2 Factory Mode Adjustments

4-2-1 Entering Factory Mode

1. To enter "Service Mode" Press the remote -control keys in this sequence :

- If you do not have Factory remote - control

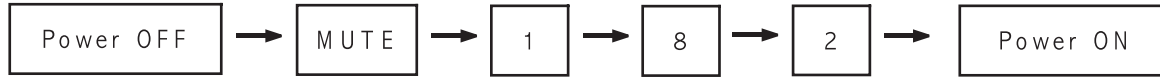

- If you have Factory remote - control



- The buttons are active in the service mode.

1. Remote - Control Key : Power, Arrow Up, Arrow Down, Arrow Left
Arrow Right, Menu, Enter, Number Key(0~9)
2. Function - Control Key : Power, CH +, CH -, VOL +, VOL -,
Menu, TV/VIDEO(Enter)

4-2-2 Factory Mode Tree

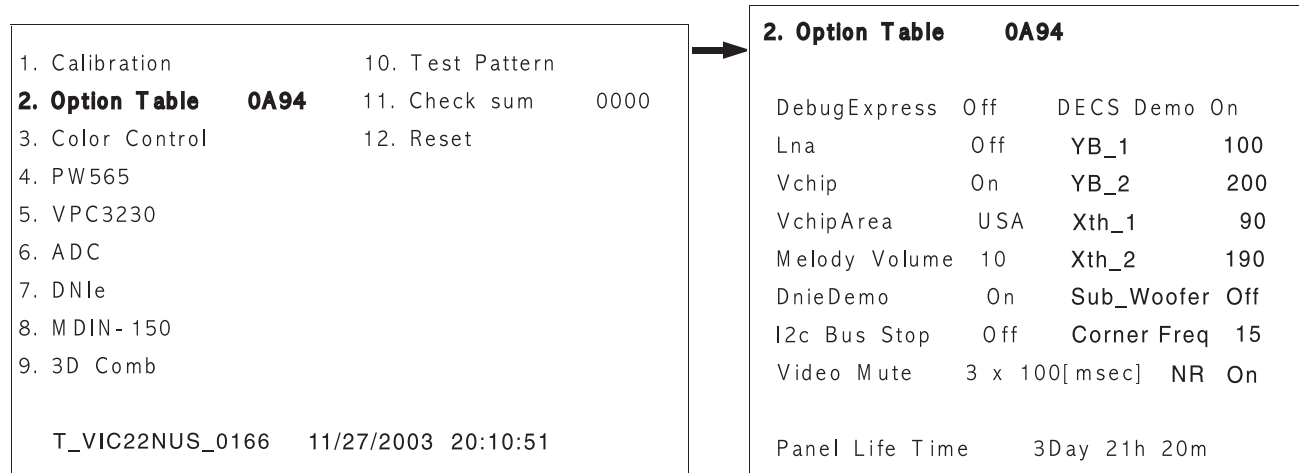
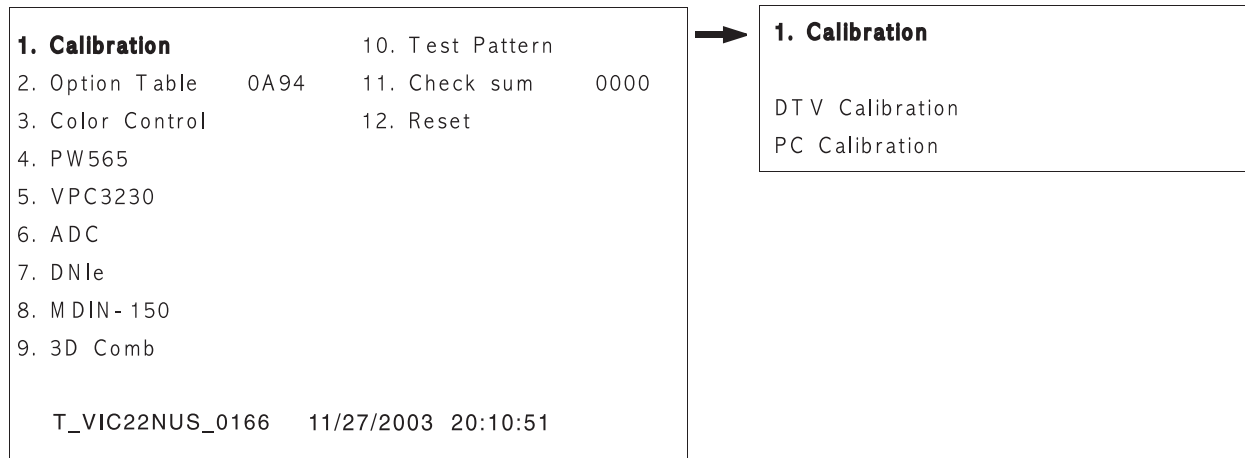

1. Calibration 10. Test Pattern
 2. Option Table 0A94 11. Check sum 0000
3. Color Control 12. Reset
 4. PW565
 5. VPC3230
 6. ADC
 7. DNle
 8. MDIN- 150
 9. 3D Comb

T_VIC22NUS_0166 11/27/2003 20:10:51

3. Color Control

Sub-Brightness	127	Sub-Contrast	95
Red Offset	130	Red Gain	128
Green Offset	128	Green Gain	128
Blue Offset	130	Blue Gain	131
Brightness	45	Contrast	100

1. Calibration 10. Test Pattern
 2. Option Table 0A94 11. Check sum 0000
 3. Color Control 12. Reset
4. PW565
 5. VPC3230
 6. ADC
 7. DNle
 8. MDIN- 150
 9. 3D Comb

T_VIC22NUS_0166 11/27/2003 20:10:51

4. PW565

Red Gain	128
Green Gain	128
Blue Gain	128
Red Offset	128
Green Offset	128
Blue Offset	128

1. Calibration 10. Test Pattern
 2. Option Table 0A94 11. Check sum 0000
 3. Color Control 12. Reset
 4. PW565
5. VPC3230
 6. ADC
 7. DNle
 8. MDIN- 150
 9. 3D Comb

T_VIC22NUS_0166 11/27/2003 20:10:51

5. VPC3230

CT	20	CIPCT	20	KILVL	09
BR	8E	PFS	02	LDLY	07
ACC_SAT	80	PK	03	PKCOR	00
TINT	32	VPK	00		
SATCb	1F	LPF2	00		
SATCr	3F	CBW2	00		
CIPTNT	20	CBW	03		
CIPBR	B5	IFC	03		

1. Calibration		10. Test Pattern	
2. Option Table	0A94	11. Check sum	0000
3. Color Control		12. Reset	
4. PW565			
5. VPC3230			
6. ADC			
7. DNle			
8. MDIN- 150			
9. 3D Comb			
T_VIC22NUS_0166 11/27/2003 20:10:51			



6. ADC			
Red Gain	8C	Pr Gain	A0
Green Gain	8C	Y Gain	A0
Blue Gain	8C	Pb Gain	A0
Red Offset	46	Pr Offset	40
Green Offset	46	Y Offset	40
Blue Offset	46	Pb Offset	40
Current	00		
VCO	00		

1. Calibration		10. Test Pattern	
2. Option Table	0A94	11. Check sum	0000
3. Color Control		12. Reset	
4. PW565			
5. VPC3230			
6. ADC			
7. DNle			
8. MDIN- 150			
9. 3D Comb			
T_VIC22NUS_0166 11/27/2003 20:10:51			



7. DNle		TV	
NR_ScaleMaxY	32	NR_SEL	3
NR_ScaleMinY	16	CE_CutOff	0
NR_ScaleMaxC	32	CE_Upper	220
NR_ScaleMinC	16	CE_Gain	255
NR_TH_HRF	7	CE_HPF_Gain	128
NR_TH_EDGE	5	DCE_Gain	32
Limit_Y	129	CTI_Gain	7
Limit_C	144	DEP_TH_Cor	15
		DEP_NR_DET_Gain	8
		DEP_R_INT	16
		BWS_B_Gain	375
		BWS_W_Gain	375
		WTE_Gain	1023
		CTE_Gain	50

1. Calibration
 2. Option Table 0A94
 3. Color Control
 4. PW565
 5. VPC3230
 6. ADC
 7. DNle
8. MDIN- 150
 9. 3D Comb

T_VIC22NUS_0166 11/27/2003 20:10:51

8. MDIN- 150

Front Noise Reduction Filter
 Horizontal Peaking Filter
 Edge Enhancement Filter
 Input Test Pattern
 Output Test Pattern
 Deinterlace Control

8. MDIN- 150

Front Noise Reduction Filter

Noise_Reduction_Flt0	256	Noise_Reduction_Flt_On	0
Noise_Reduction_Flt1	0	Noise_Reduction_Flt_Difference	0
Noise_Reduction_Flt2	0	Median_Flt_On	0
Noise_Reduction_Flt3	0	Median_Flt_Difference	0
Noise_Reduction_Flt4	0	Noise_Reduction_Flt_Diff_Sel	0
Noise_Reduction_Flt5	0		
Noise_Reduction_Flt6	0		
Noise_Reduction_Flt7	0		

8. MDIN- 150

Horizontal Peaking Filter

H_Peaking_Flt0	48	H_Peaking_Flt_Enable	1
H_Peaking_Flt1	11	H_Peaking_Flt_Gain	16
H_Peaking_Flt2	994	H_Peaking_No_Sum	0
H_Peaking_Flt3	1010	H_Peaking_Inverse	0
H_Peaking_Flt4	4		
H_Peaking_Flt5	2		
H_Peaking_Flt6	1		
H_Peaking_Flt7	0		

8. MDIN- 150

Edge Enhancement Filter

Edge_Cor_Offse	8
Edge_Enh_Level	2
Edge_Enh_2D_Flt_Enable	1

8. MDIN- 150

Input Test Pattern

In_Test_RGB	0
In_Test_Ptrn	0
In_Test_Format	0

8. MDIN- 150

Output Test Pattern
 Out_Test_Ptrn 0
 Out_Dark_Scrn_Main 0

8. MDIN- 150

Deinterlace Control

Deint_Mode	1	Deint_Edge_En	2	Deint_Film_Min	0
Deint_C_Delay_Sel	0	Deint_Edge_Thres	255	Film_Mode_Thres	5
Median_Tap	0	Film_Invaild_Lines	8	Bad_Edit_En	1
Expander_Tap	0	Film32_Mo_Thres	160	Caption_Mode	3
Deint_Thres	20	Film_Mode	5	D_Caption_V_Pos	160
Fast_Mode	1	D_Film_Slide_Cnt	0	Deint_Disp_Color	0
N_Median_Tap	1	D_Film_Slide_Cor	40	Deint_Disp_Mode	0
D_Fast_Mode_Thres	4	Deint_Film_Plus	1	MDIN_Tint	90
N_Deint_Thres	24	Deint_Film_Minus	3		
Very_Fast_En	1	Deint_Film_Max	3		

- 1. Calibration
- 2. Option Table 0A94
- 3. Color Control
- 4. PW565
- 5. VPC3230
- 6. ADC
- 7. DNie
- 8. MDIN- 150
- 10. Test Pattern
- 11. Check sum 0000
- 12. Reset

9. 3D Comb

T_VIC22NUS_0166 11/27/2003 20:10:51



9. 3D Comb

Register Part 1
 Register Part 2

9. 3D Comb

Register Part 1

YAPS	1	DYCOS	2	YNRLIM	1	VTRH	1
COUTS	1	CDL	4	YNRINV	0	WSC	1
NRMD	0	HDP	0	YNRK	0	TT	0
KILS	0	CPP	0	ST0S	1	FELCHK	1
MSS	0	DYGAIN	9	ST1S	3	TH	0
NSDS	0	DYCOR	2	CLK8OFF	1	IS1DECON	1
CLKS	0	DCGAIN	6	IDWOA2	0	WSS	0
EXCSS	1	DCCOR	3	ID1WOA1	0	VAINV	18
PECS	0	CNRLIM	1	ID1ON	0	VAPGAIN	3
MFREEZE	0	CNRINV	0	LDSR	2	YPFG	3
EXADINS	0	CNRK	0	VTRR	1	YPFT	3

9. 3D Comb

Register Part 2

SELD2FH	0	YHCGAIN	0	FSCFG	0	ADPDS	1
CLPH	0	YHCOR	0	BPLLFS	1	ADCLKS	2
COHS	0	CLKGT	0	HPLLFS	0	HIZEN	0
CC3N	0	CLKGEB	0	VSSL	8		
VEGS	2	CLKGGT	0	HSSL	15		
V1PS	2	CLKG2D	1	BGPW	3		
SELD1FL	0	OTT	0	BGPS	7		
KCTT	0	VCT	0	VT VH	0		
CSHDT	0	SHT	0	FSCOFF	0		
OVST	0	KILR	2	NRZOFF	0		
ED2OFF	0	PLLFG	1	NSDSW	0		

4 Alignments and Adjustments

1. Calibration		10. Test Pattern	
2. Option Table	0A94	11. Check sum	0000
3. Color Control		12. Reset	
4. PW565			
5. VPC3230			
6. ADC			
7. DNle			
8. MDIN - 150			
9. 3D Comb			
T_VIC22NUS_0166 11/27/2003 20:10:51			



10. Test Pattern
1) Luma Ramp (16 step)
2) Luma Ramp (128 Step)
3) White 16
4) White 240
5) Color Bar
6) RGB Ramp (32 Step)

1. Calibration		10. Test Pattern	
2. Option Table	0A94	11. Check sum	0000
3. Color Control		12. Reset	
4. PW565			
5. VPC3230			
6. ADC			
7. DNle			
8. MDIN - 150			
9. 3D Comb			
T_VIC22NUS_0166 11/27/2003 20:10:51			

1. Calibration		10. Test Pattern	
2. Option Table	0A94	11. Check sum	0000
3. Color Control		12. Reset	
4. PW565			
5. VPC3230			
6. ADC			
7. DNle			
8. MDIN - 150			
9. 3D Comb			
T_VIC22NUS_0166 11/27/2003 20:10:51			

* Unless otherwise specified, do not adjust data in Factory Mode.

* Data may be changed for display improvement.

4-3 White Balance Adjustment

1. In factory mode (1, 3, 6), you can adjust the white balance.
2. As the adjustment and data values differ depending on input sources, different adjustments are required for RF, DTV (Component 1, 2) and PC/DVI modes.
3. Optimum condition data for each mode are saved as default values. (Refer to Table 2, 3)
4. As the RF mode is applied with the same values as for VIDEO and S-VIDEO, adjustment can be made in any of RF, VIDEO and S-VIDEO modes.

Table 4-1. White Balance Setting Conditions

Mode	High Light			Low Light		
	"x"	"y"	Y	"x"	"y"	Y
RF	255	260	Fix	270	260	0.45fL
DTV	255	260	Fix	270	260	0.7fL
PC	255	260	Fix	270	260	1.4fL

Table 4-2. Color Control Default Value

Mode	RF	DTV	PC	Mode	RF	DTV	PC
Sub-Brightness	127	131	149	Sub-Contrast	95	65	42
Red Offset	130	133	128	Red Gain	128	128	128
Green Offset	128	128	128	Green Gain	128	128	128
Blue Offset	130	131	128	Blue Gain	131	128	128
Brightness	45	45	50	Contrast	100	100	80

Table 4-3. Color Control Default Value

Mode	PC	Mode	DTV
Red Gain	8C	Pr Gain	A0
Green Gain	8C	Y Gain	A0
Blue Gain	8C	Pb Gain	A0
Red Offset	46	Pr Offset	40
Green Offset	46	Y Offset	40
Blue Offset	46	Pb Offset	40
Current	05		
VCO	02		

4-3-1 Conditions for Measurement

1. On the basis of toshiba ABL pattern : High Light level (57 IRE)
 - INPUT SIGNAL GENERATOR : MSPG-925LTH
 - * Mode NO 1 : 750X480@60 Hz
 - NO 6 : 1280X720@60 Hz
 - NO 21 : 1024X768@60 Hz
 - * Pattern NO 36 : 16 Color Pattern
 - NO 16 : Toshiba ABL Pattern
2. Optical measuring device : CA210 (FL)
Please use the MSPG-925 LTH generator for model LTP227W.

4-3-2 Method of Adjustment

1. Adjust the basic level of DTV and PC input signals.
 - a) Set the input to the mode in which the adjustment will be made (DTV → PC).
 - * Input signal - DTV Mode : Model #6 (1280*720 Mode), Pattern #36
 - PC Mode : Model #21 (1024*768 Mode), Pattern #16 (Picture 4-1)
 - b) Enter factory Calibration, confirm the ADC data (DTV, PC Mode Only).
 - * ADC default value : Table 4-3.

Picture 4-1 Toshiba ABL Pattern

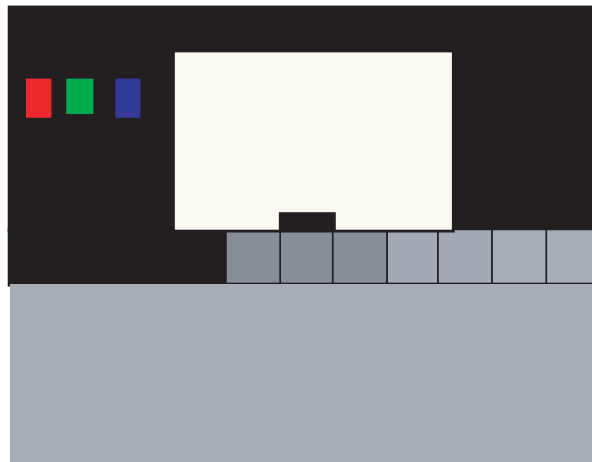

2. Adjust the white balance of RF, DTV and PC Modes.
 - a) Set the input to the mode in which the adjustment will be made (RF → DTV → PC).
 - * Input signal - VIDEO Mode : Model #1 (750*480 Mode), Pattern #16
 - DTV Mode : Model #6 (1280*720 Mode), Pattern #16
 - PC Mode : Model #21 (1024*768 Mode), Pattern #16
 - b) Enter factory color control, confirm the data.

- c) Adjust the low light. (Refer to table 1, 2 in adjustment position by mode)
- Adjust sub - Brightness to set the 'Y' value.
 - Adjust red offset ('x') and blue offset ('y') to the color coordinates.
- * Do not adjust green offset data.

Picture 4-2 Toshiba ABL Pattern

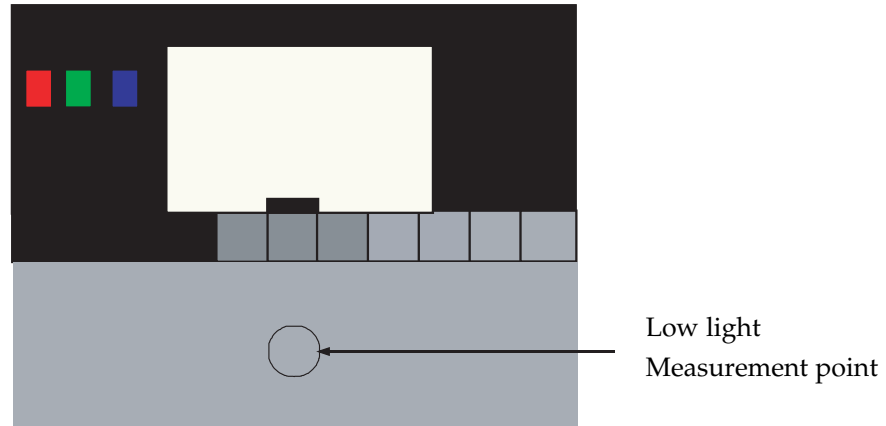

- d) Adjust the high light. (Refer to table 1, 2 in adjustment position by mode)
- Adjust red gain ('x') and blue gain ('y') to the color coordinates.
- * Do not adjust the green gain and sub-contrast (Y) data.

Picture 4-3 Toshiba ABL Pattern

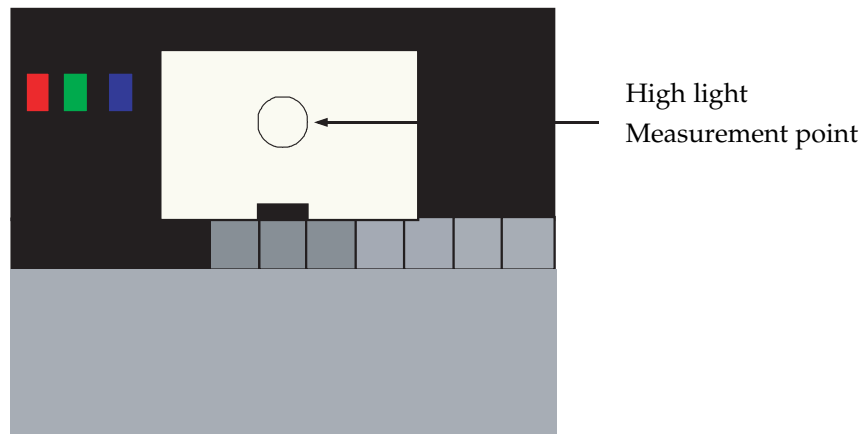

4-3-3 Option Table

Option	Default	Option 1	Option 2	Option 3	Remark
DebugExpress	Off	Off (FIX)	Off (FIX)	Off (FIX)	* When a Jig control use to On
LNA	Off (FIX)	Off (FIX)	Off (FIX)	Off (FIX)	-
Vchip	On	On	On	On	-
VchipArea	USA	USA+ Canada	USA	USA+ Canada	-
Melody Volume	10	10	0 ~ 19	0 ~ 19	0 ~ 19
DnieDemo	On	On	On	On	-
I2c Bus Stop	Off	Off	Off	Off	-
Video Mute	3 X 100	3 X 100	3 X 100	3 X 100	[msec]
DECS Demo	On	On	On	On	-
YB_1	100	100	100	100	1 ~ 255
YB_2	200	200	200	200	1 ~ 255
Xth_0	90	90	90	90	1 ~ 254
Xth_1	190	190	190	190	10 ~ 254
Sub_Woofer	Off	Off	Off	Off	Don't Adjust
Corner Freq.	15	15	15	15	Don't Adjust
Data	0A94	0A9C	0094~ 1394	009C~ 139C	00XX ~ 13XX

* The default settings are most recommended for Option Data. Each data may be adjusted.

4-3-4 PW565

* Below figures are for contrast adjustment of PW565 (IC565). Do not change the data.

Mode	Data
Red Gain	128
Green Gain	128
Blue Gain	128
Red Offset	128
Green Offset	128
Blue Offset	128

4-3-5 VPC 3230-MAIN

* Data may be adjusted.

MODE	Data	MODE	Data
CT	20	PK	03
BR	8E	VPK	00
ACC_SAT	80	LPF2	00
TINT	32	CBW2	00
SATCb	1F	CBW	03
SATCr	3F	IFC	03
CIPNT	20	L1LVL	0C
CIPBR	B5	LDLY	07
CIPCT	20	PKCOR	01
PFS	02		

4-3-6 ADC

*Adjust the R(Pr), G(Y), B(Pb) gain and offset to the basic level of DTV and PC Input signals.

Mode	PC	Mode	DTV
Red Gain	8C →Adjust	Pr Gain	A0 →Adjust
Green Gain	8C →Adjust	Y Gain	A0 →Adjust
Blue Gain	8C →Adjust	Pb Gain	A0 →Adjust
Red Offset	46 →Adjust	Pr Offset	40 →Adjust
Green Offset	46 →Adjust	Y Offset	40 →Adjust
Blue Offset	46 →Adjust	Pb Offset	40 →Adjust
Current	05		
VCO	02		

4-3-7 DNle

* Control the specify item that a output signals of scalar (PW565).

* This data can be changed without notice.

Mode	Data	Mode	Data	Mode	Data
NR_ScaleMaxY	32	NR_SEL	3	DEP_NR_DET_Gain	8
NR_ScaleMinY	16	CE_CutOff	0	DEP_R_INT	16
NR_ScaleMaxC	32	CE_Upper	220	BWS_B_Gain	375
NR_ScaleMinC	16	CE_Gain	255	BWS_W_Gain	375
NR_TH_HRF	7	CE_HPF_Gain	128	WTE_Gain	1023
NR_TH_EDGE	5	DCE_Gain	32	CTE_Gain	50
Limit_Y	129	CTI_Gain	7		
Limit_C	144	DEP_TH_Cor	15		

4-3-8 MDIN-150

* Control the specify item that a output signals (RF, CVBS, S-VHS Modes) of MDIN-150 (IC405).

* This data can be changed without notice.

4-3-9 3D Comb

* Control the specify item that a input signals (RF, CVBS, S-VHS Modes) of D64083 (IC303).

* This data can be changed without notice.

4-3-10 Test Pattern

* Use below test patters to demonstrate the image display of PW565 (IC565).

- 1) Luma Ramp (16 step)
- 2) Luma Ramp (128 Step)
- 3) White 16
- 4) White 240
- 5) Color Bar
- 6) RGB Ramp (32 Step)

4-3-11 Check sum

* XXXX : Displays the current check sum size of the MICOM.
(Varies depending on program update)

4-3-12 Reset

* Initializes the data in the MICOM. (Set to default value)

Use 'Reset' to restore adjustmints made in Factory Mode to the original settings.

4-3-13 T_VIC22NUS_0166 11/27/2003 20:10:51

* Displays the MICOM program version

4-4 How to use SW(FlashupgradNT) for LTP227W Set program update

1. Store program practice file in new folder.
2. Connect Set and Jig Cable to execute Program Update.
(Refer to the Picture 4-4 attachment)
3. After completing the JIG Cable connection, store Update practice program (hex file 3EA) in new folder.
(guiR, romcode, factoryGui).
4. Click FlashupgradNT.exe icon 2 times and execute it.
(Upgrader OSD screen is marked)

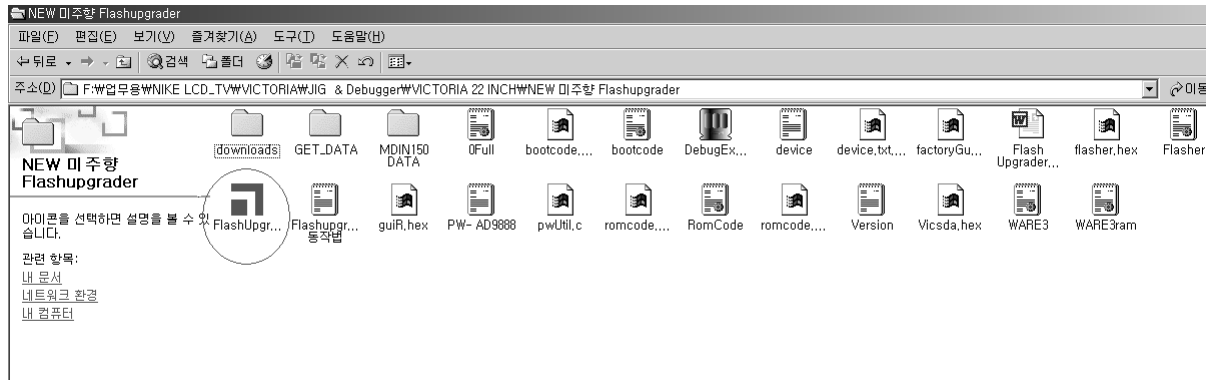

Picture 4-4

5. Select OFull.inf in Flash.
(flaher, romcode, guir, factorygui items look in Files To)

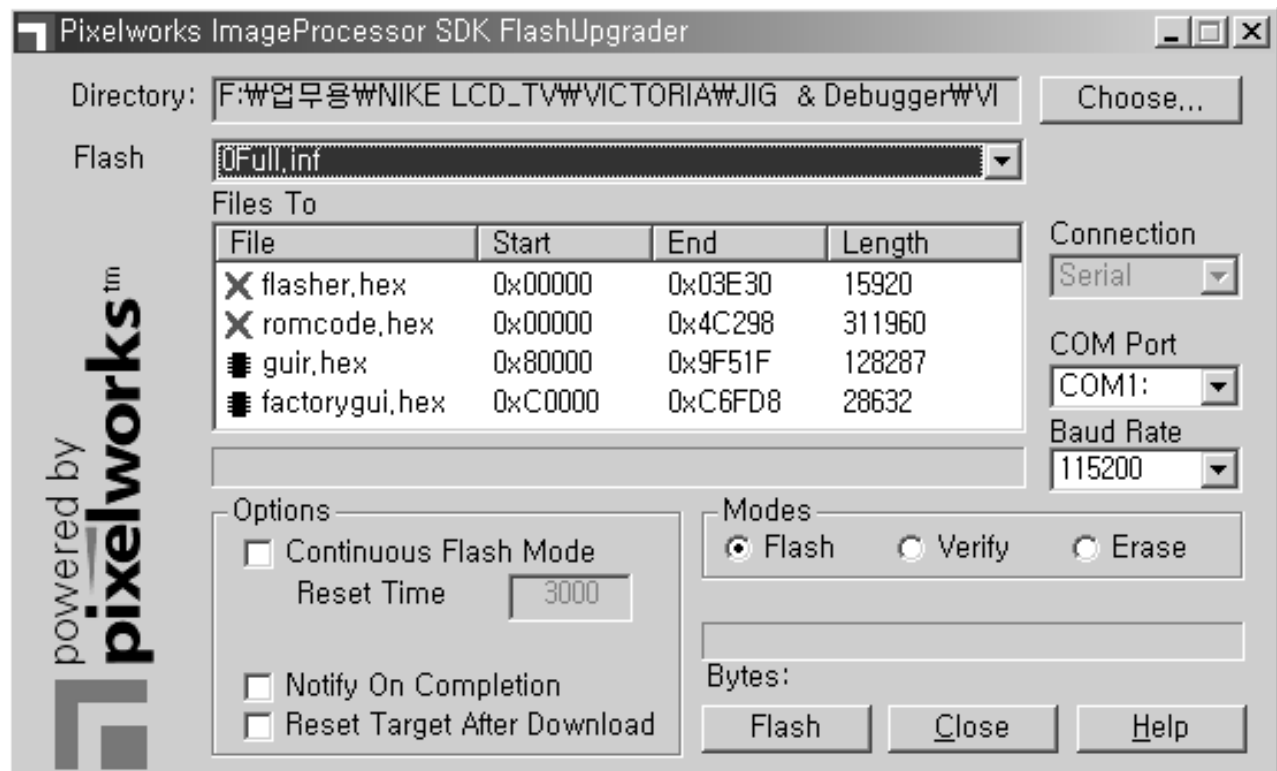

Picture 4-5

6. Click the “Flash” that is under right of OSD screen.
(if warning message comes out, Click the “Yes”(Y).)

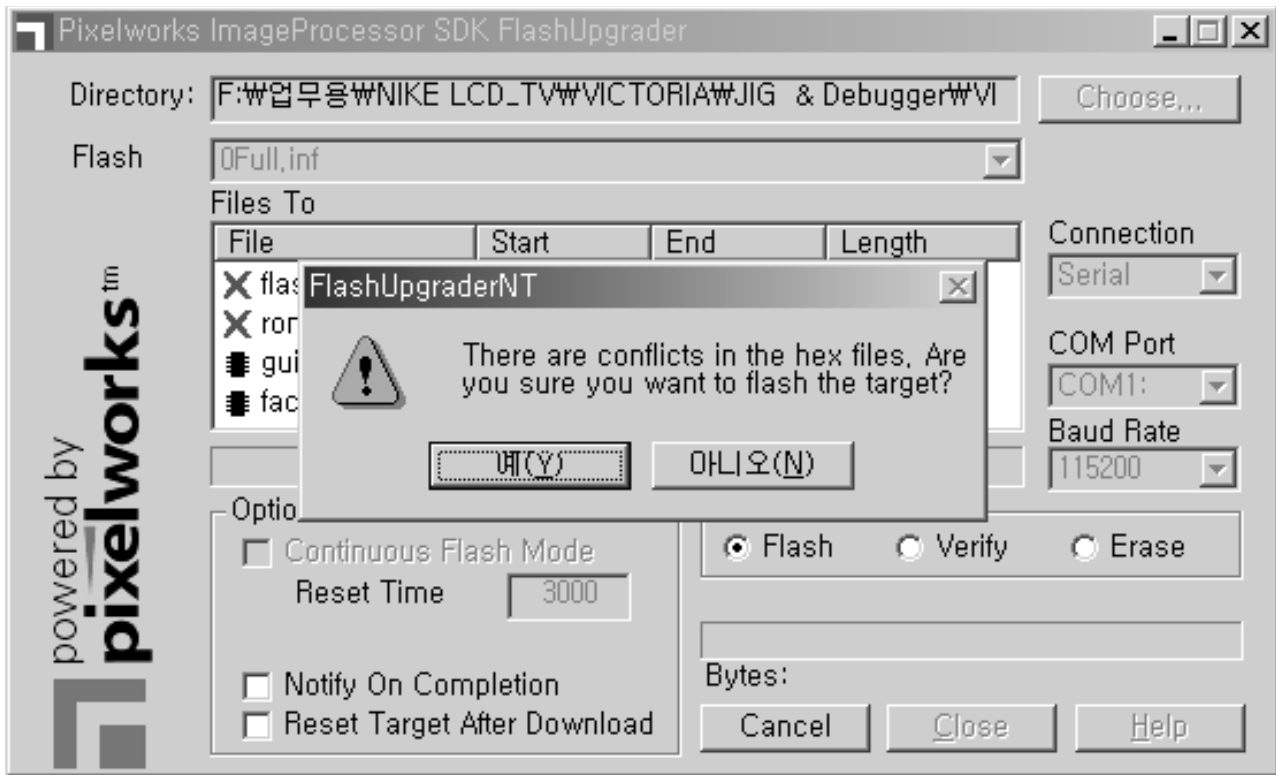

Picture 4-6

7. After acting No.6, extract Set’s Power Cable and connect it again.
8. During acting No.7, program Update sledding is marked sequentially on OSD screen.
9. After Program Update completion, act NO.7 again.
10. Program Update is completed.

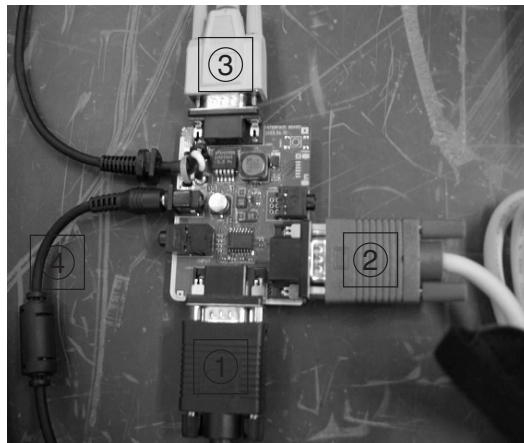

Picture 4-7

<Attachment Picture 4-7 : JIG Cable Connection Explain>

1. Connect with PC Pattern Generator’s output.
(Connect only when you want to see PC screen.)
2. Connect with JIG Output (15 pins) and PC Input (PC/DVI 24 pins) terminal.
3. Connect with COM Port1 of PC (9 Pins).
4. Connect 14V 4.5A Adaptor Cable.

5 Troubleshooting

5-1 No Power

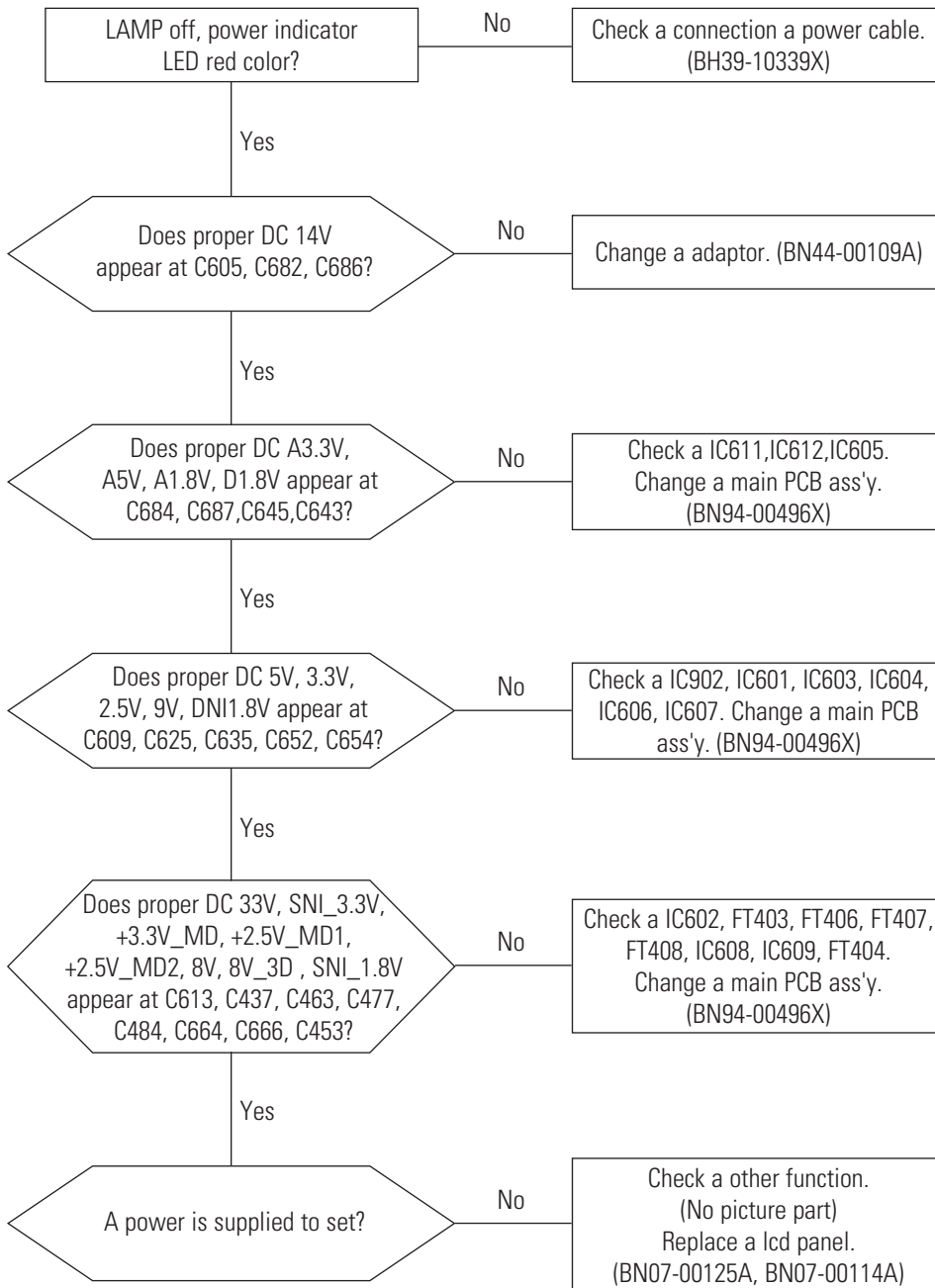

5-2 No Video (Analog PC Signal)

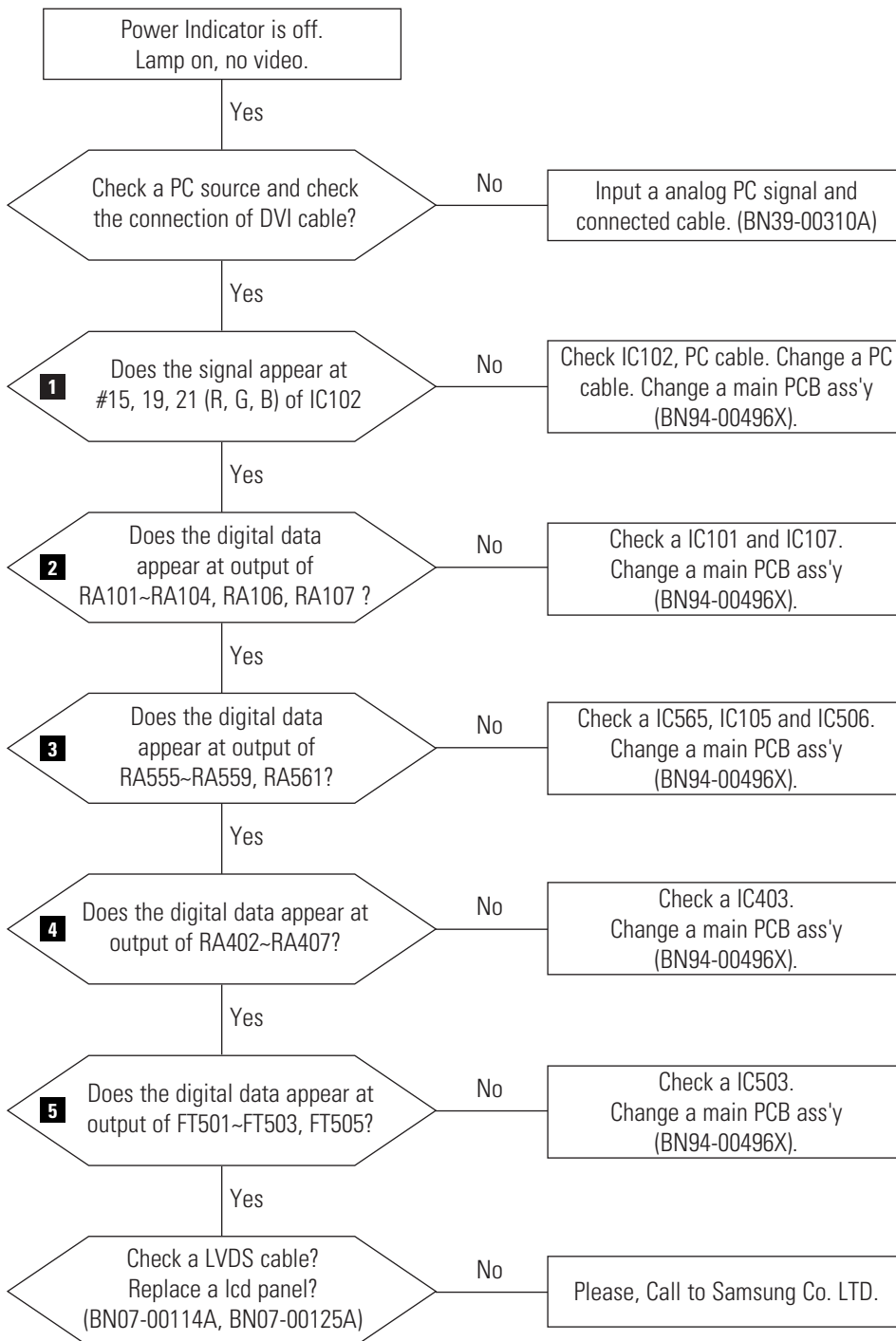

WAVEFORMS

1 R,G,B Output Signal (#15,19,21) Of IC102

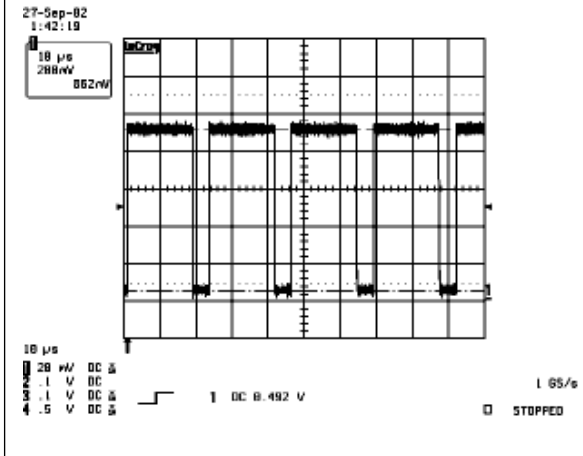

2 R,G,B Output Signal Of IC101

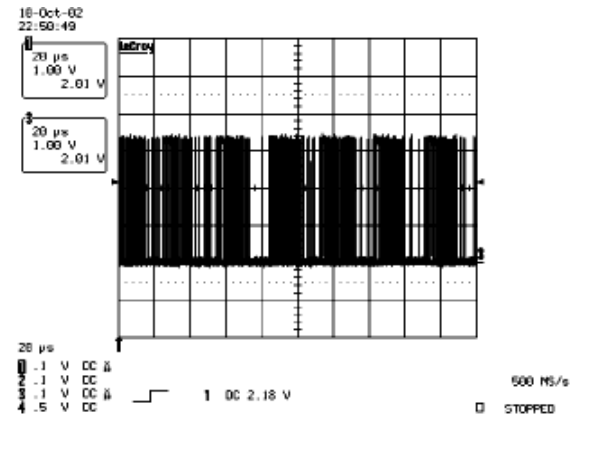

3 Output Digital Signal of IC565

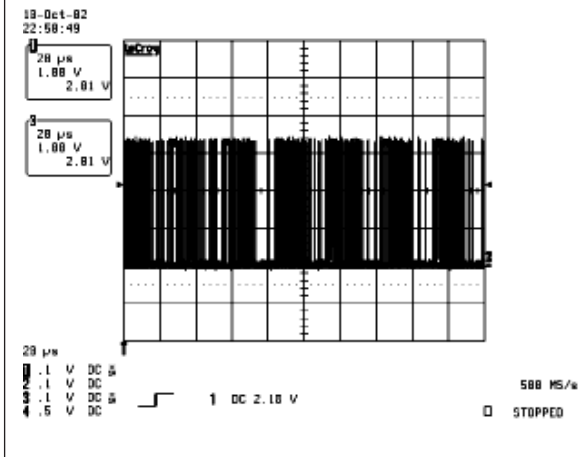

4 Output Digital Signal of IC403

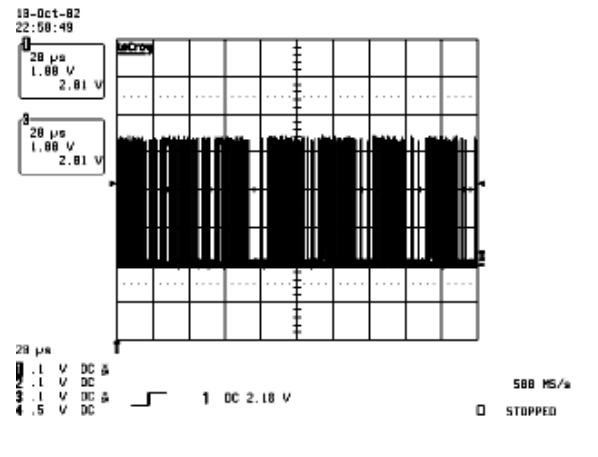

5 Digital Output Data of IC503

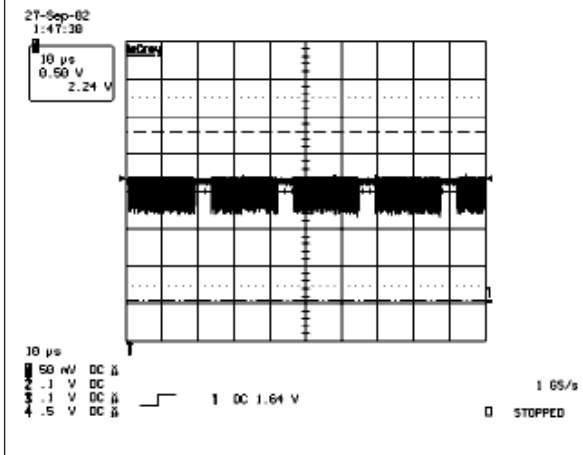

5-3 No Video (Digital PC Signal)

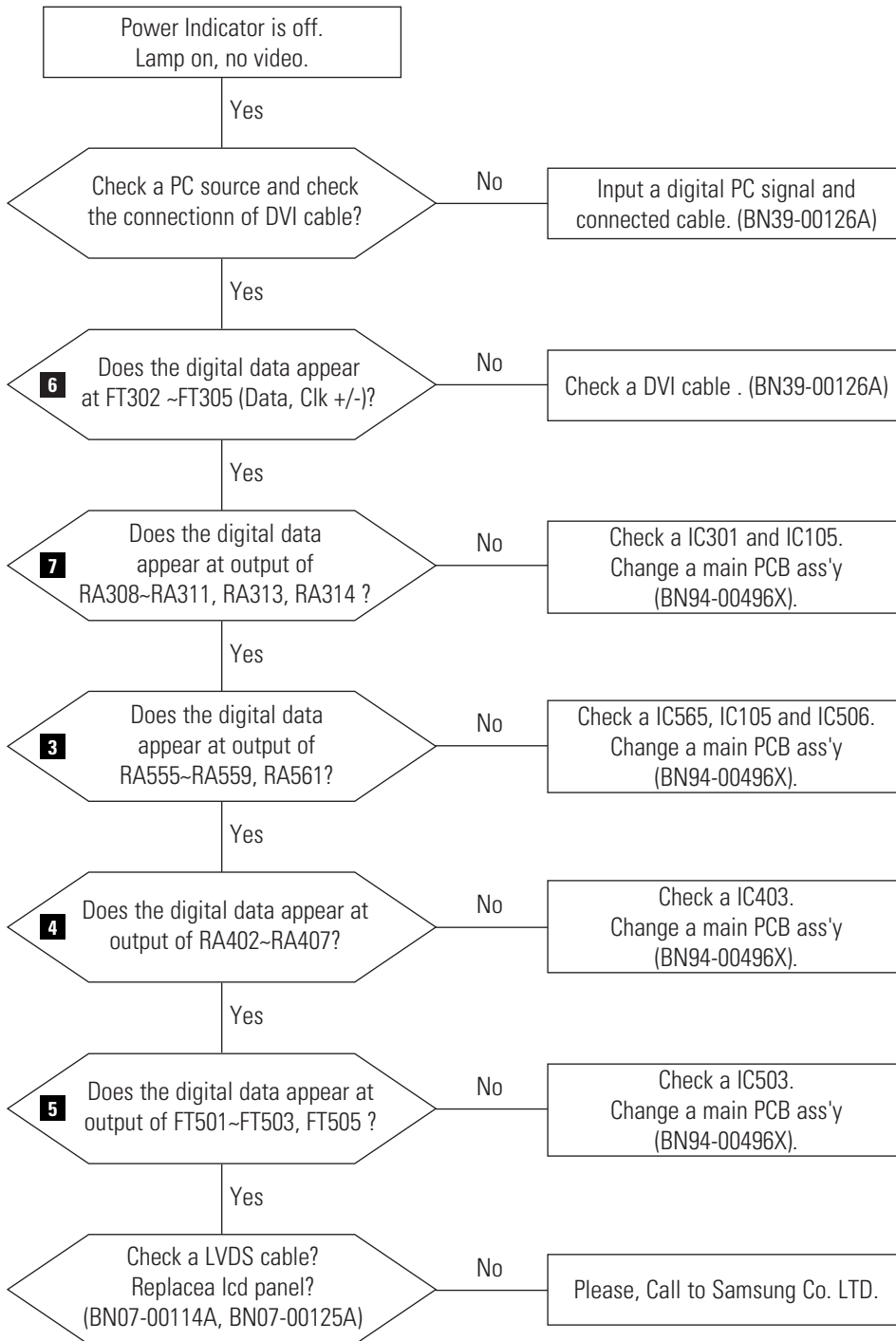

WAVEFORMS

3 Output Digital Signal of IC565

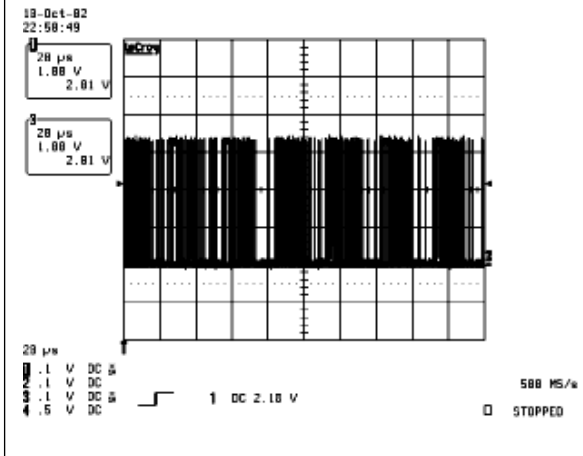

4 Output Digital Signal of IC403

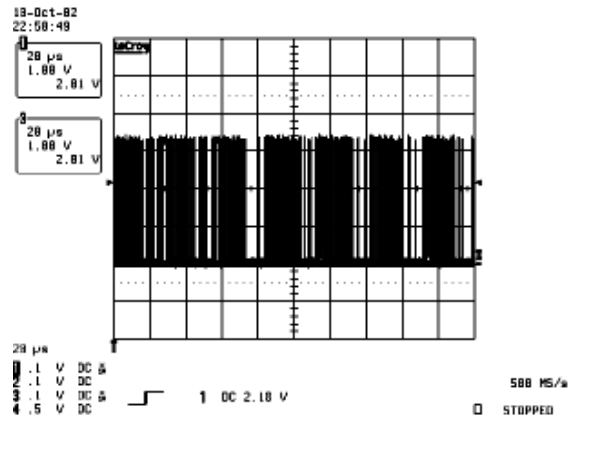

5 Digital Output Data of IC503

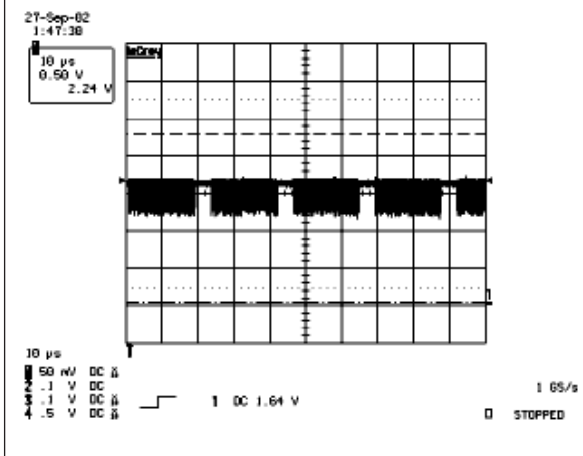

6 Signal of DVI_RX 0~2 (Data)

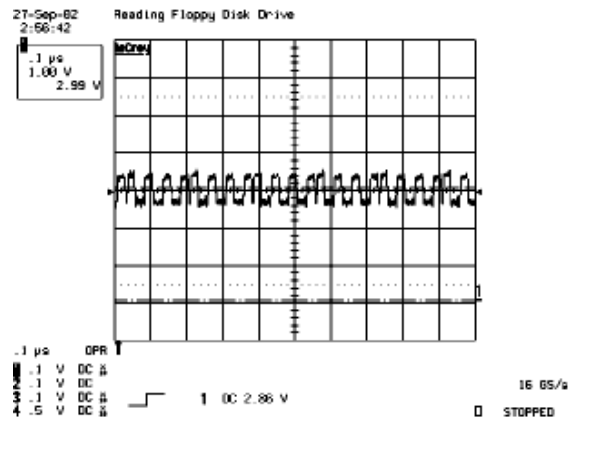

6-1 Signal of DVI_RXC (CLK)

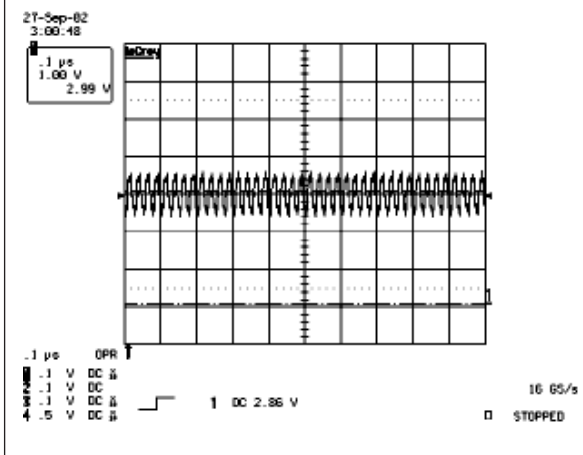

7 Digital Output Signal Of IC301

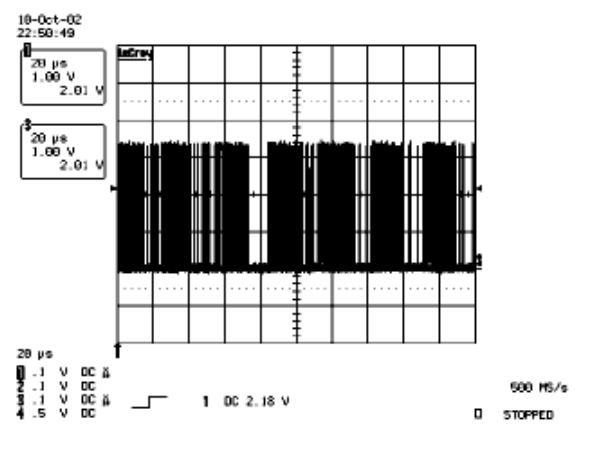

5-4 No Picture (Tuner_CVBS)

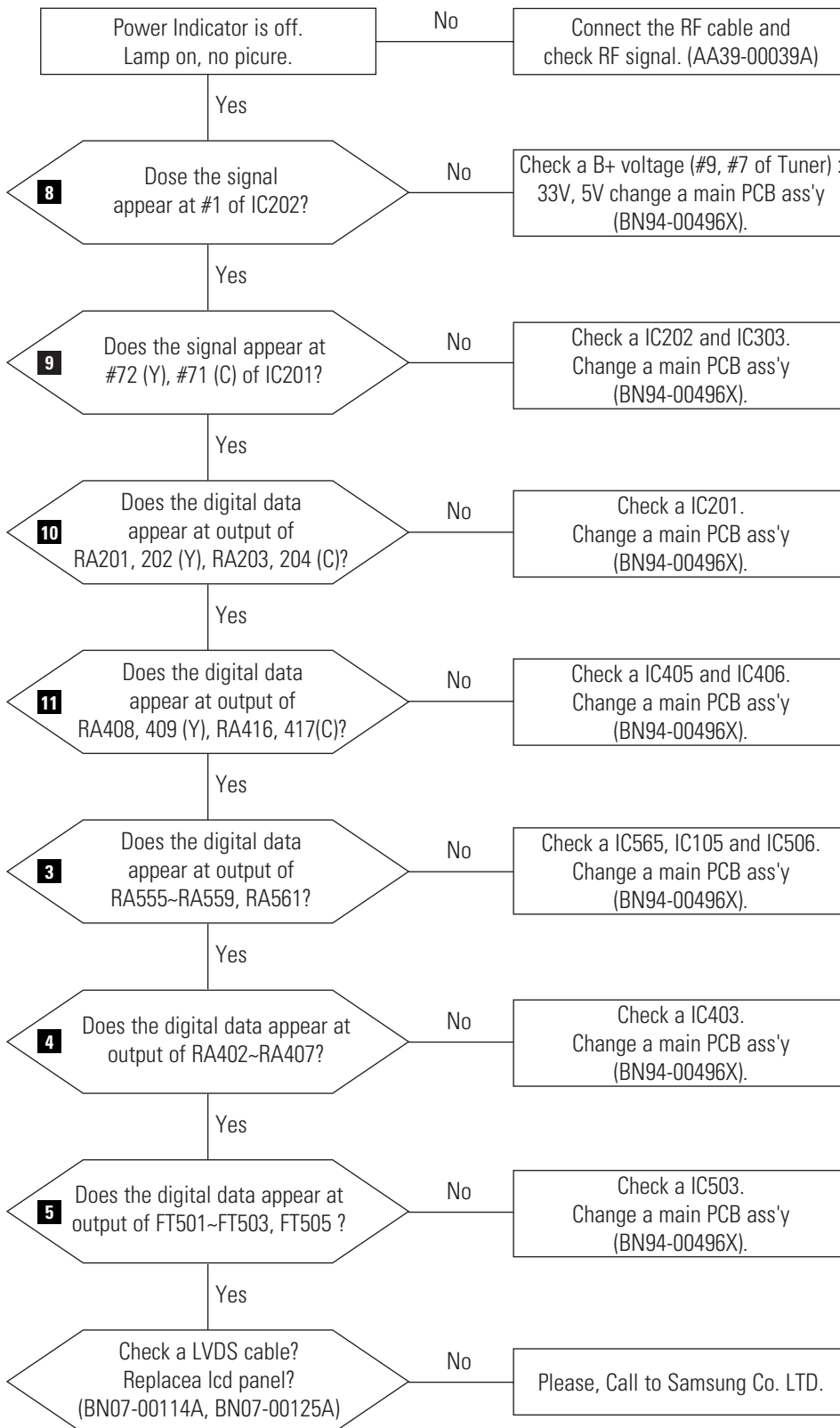

WAVEFORMS

3 Output Digital Signal of IC565

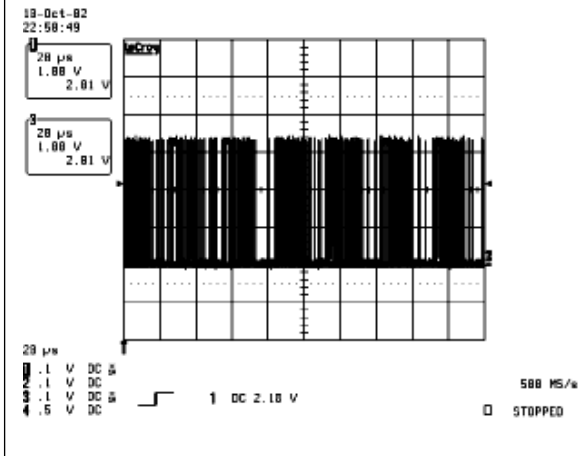

4 Output Digital Signal of IC403

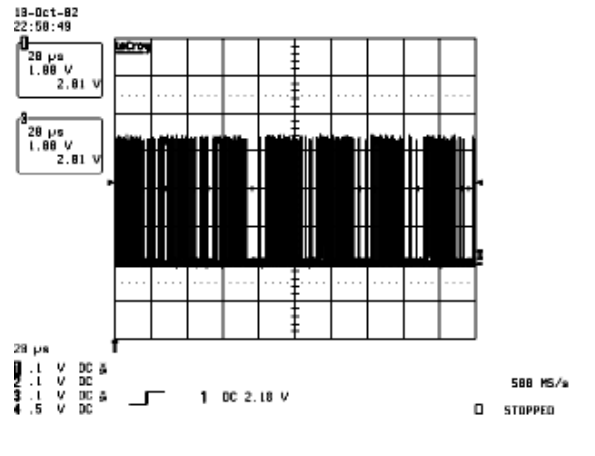

5 Digital Output Data of IC503

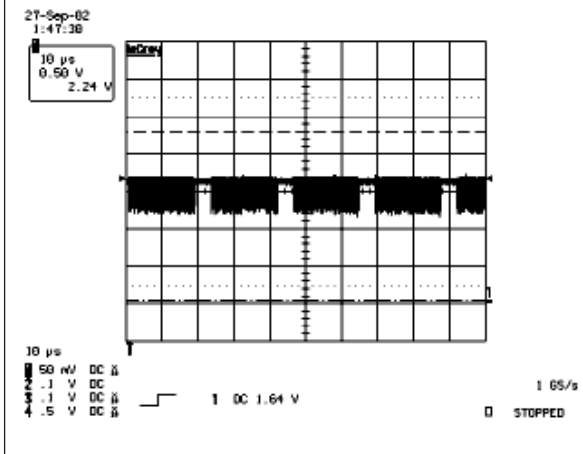

8 Tuner_CVBS Output Signal

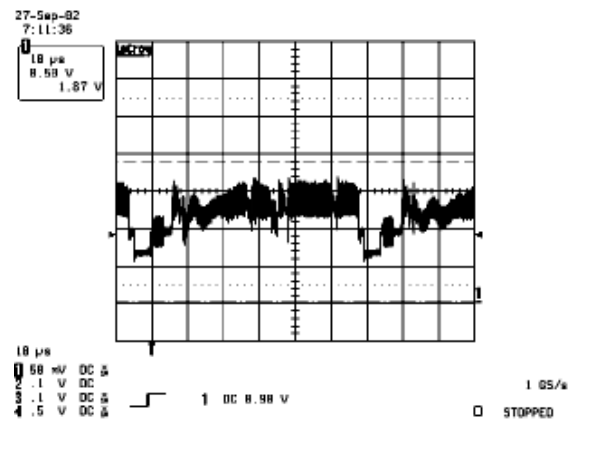

WAVEFORMS

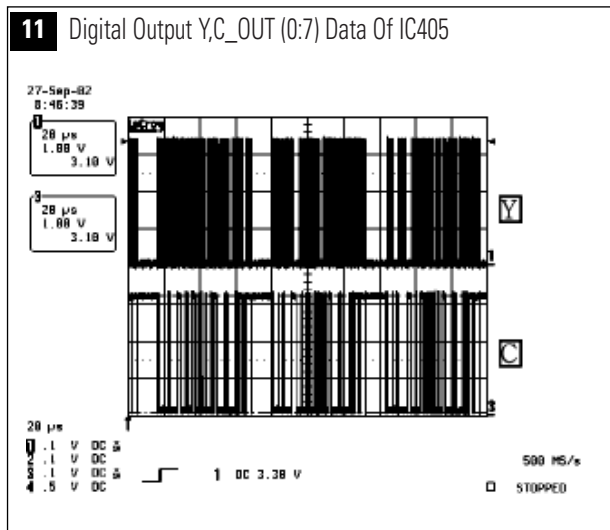
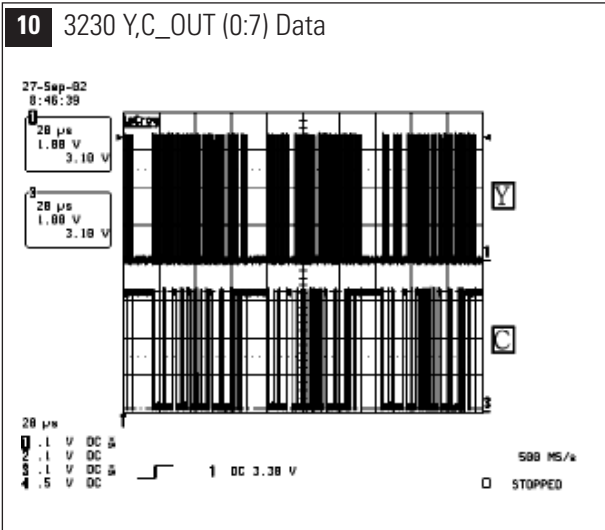
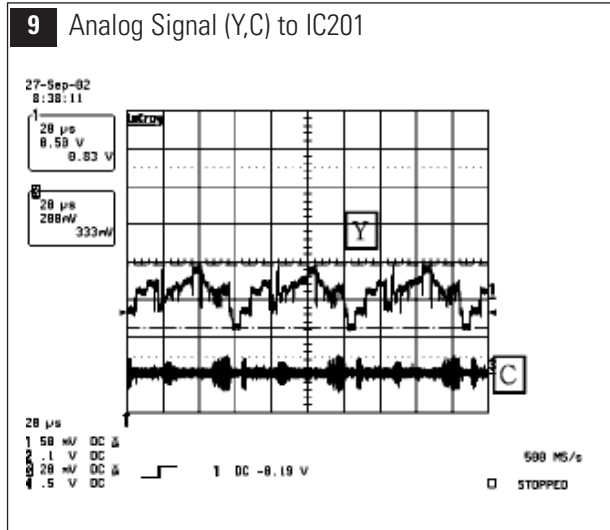

5-5 No Picture (Video_CVBS)

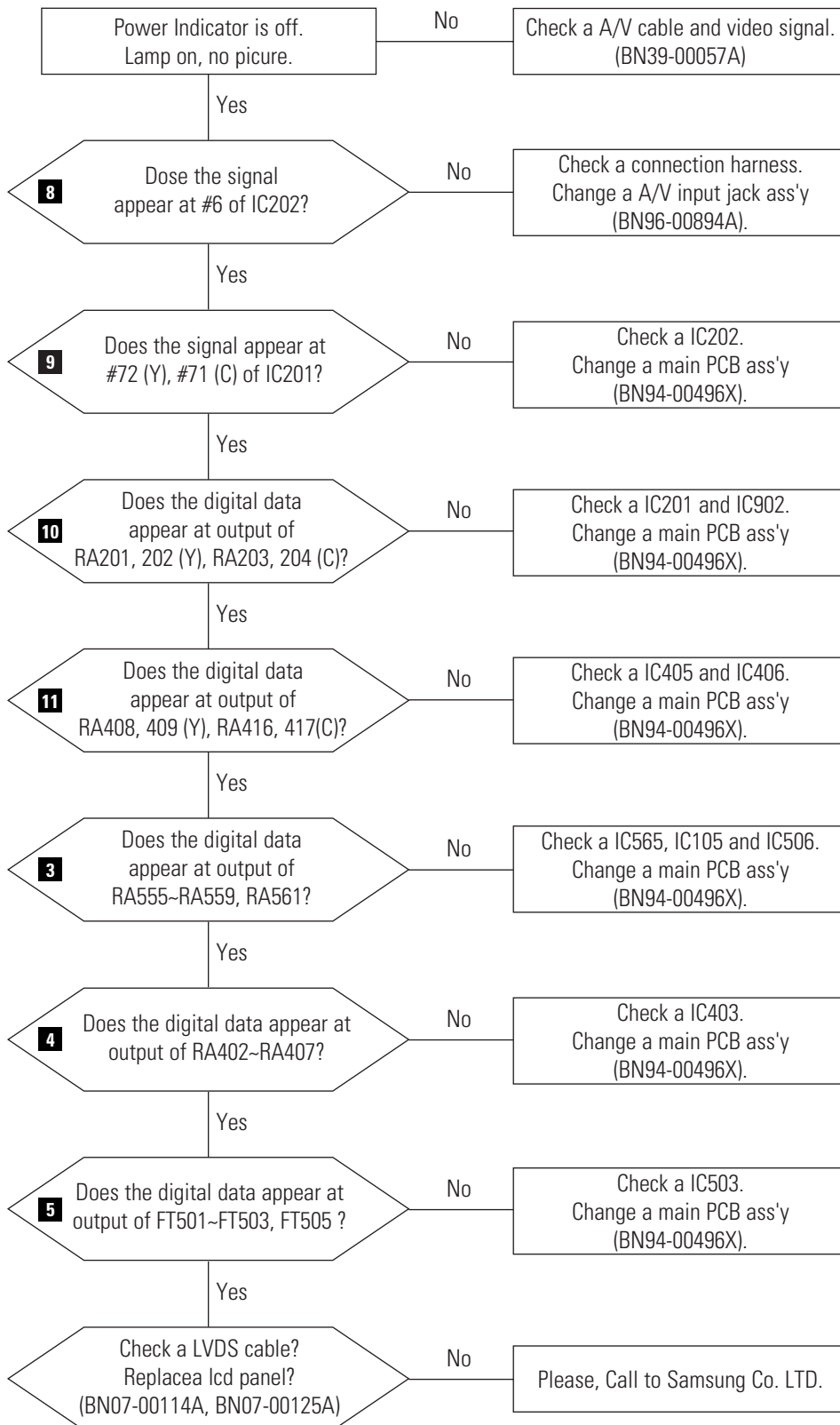

WAVEFORMS

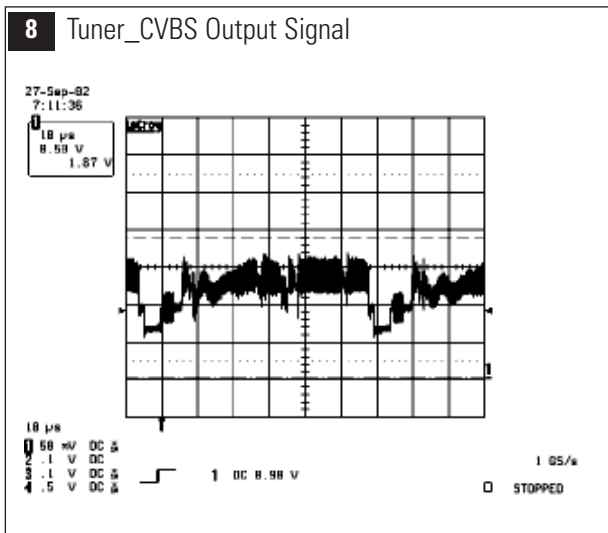
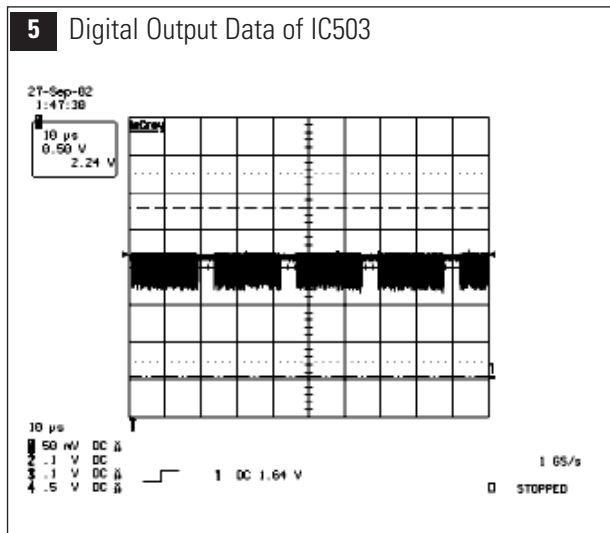
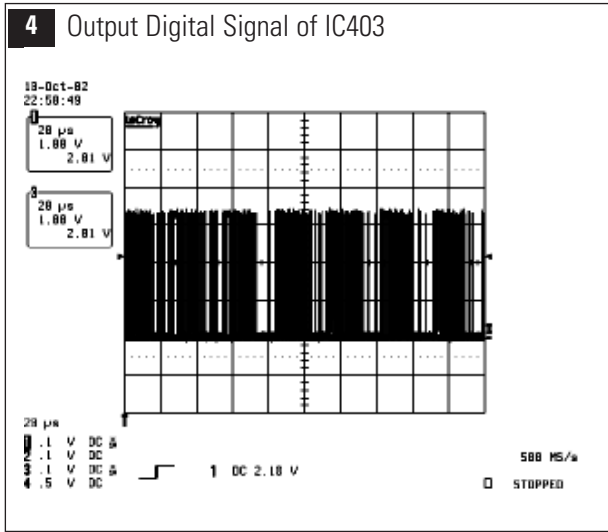
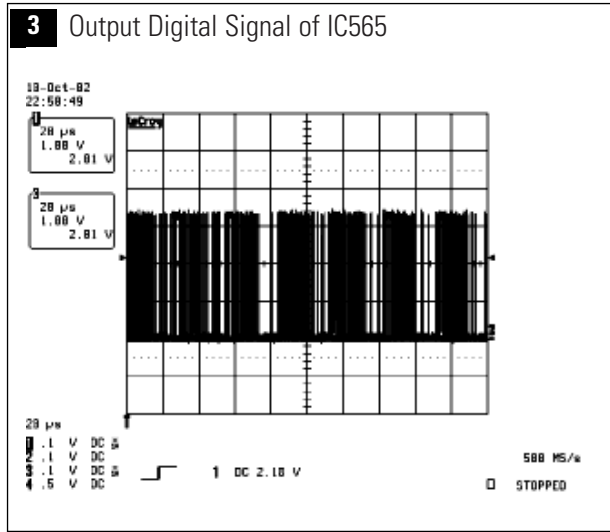

WAVEFORMS

9 Analog Signal (Y,C) to IC201

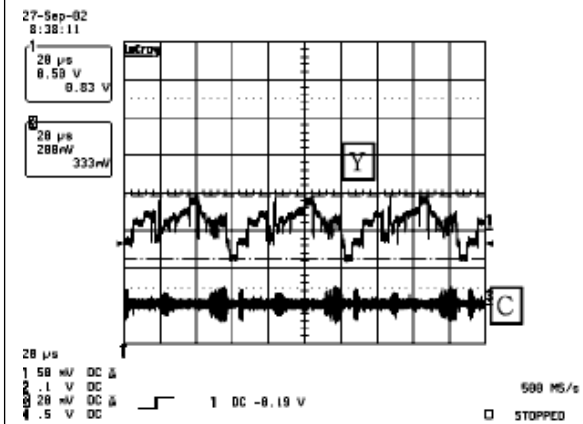

10 3230 Y,C_OUT (0:7) Data

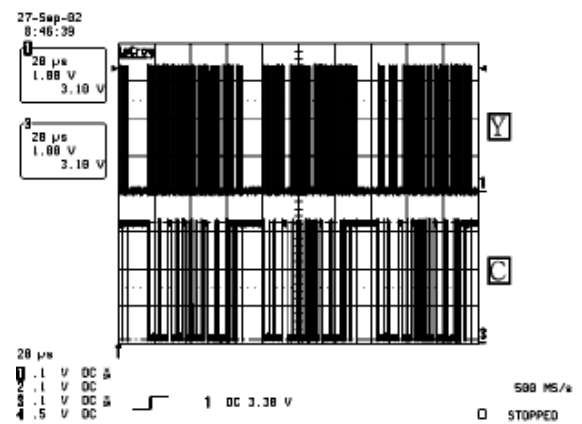

11 Digital Output Y,C_OUT (0:7) Data Of IC405

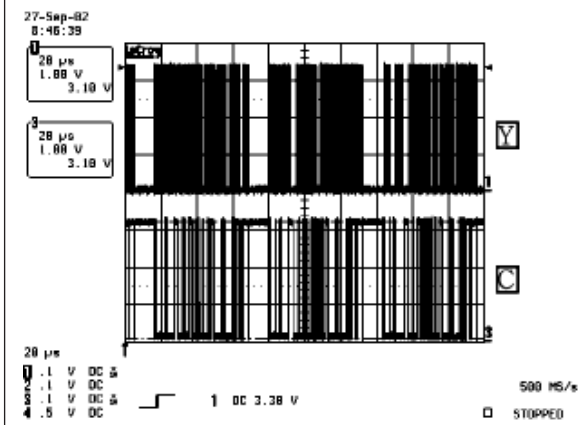

5-6 No Picture (S-VIDEO_Y,C)

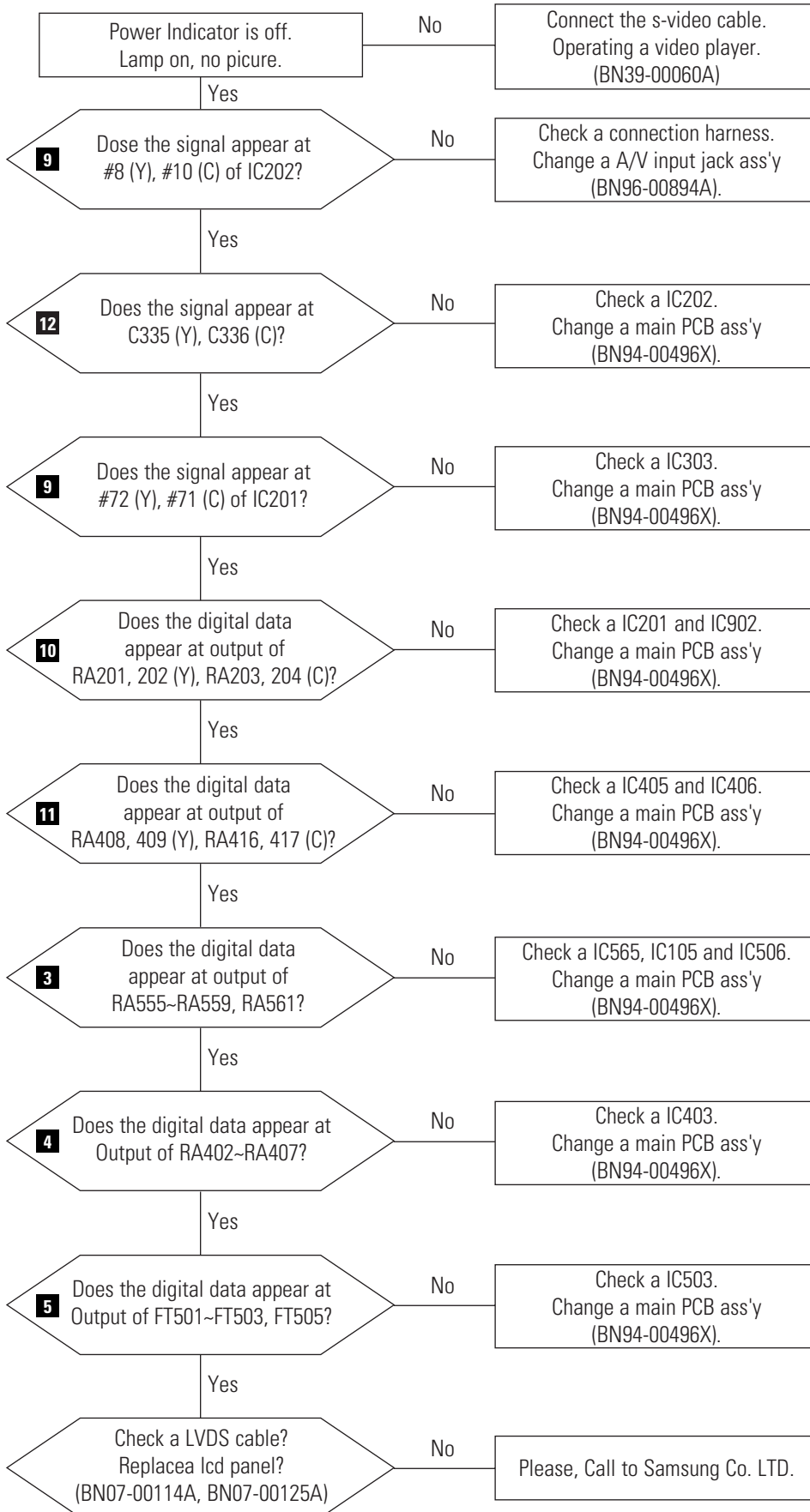

WAVEFORMS

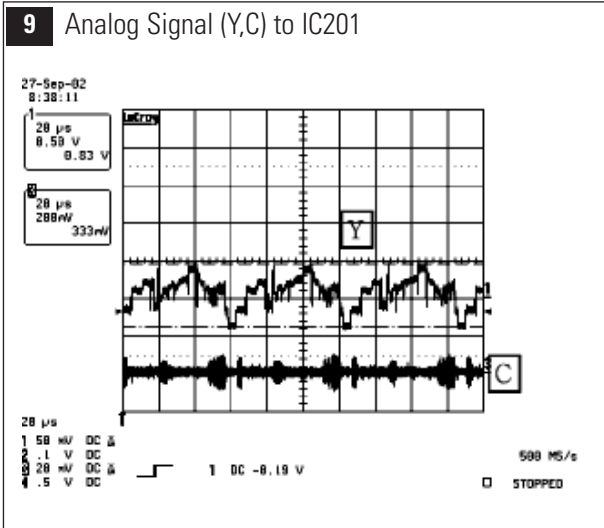
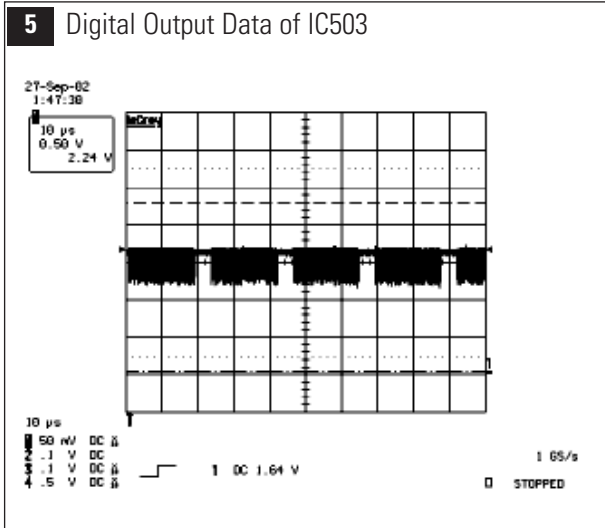
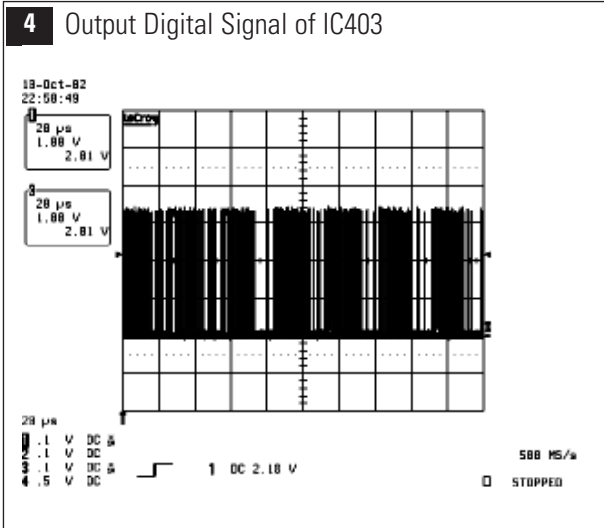
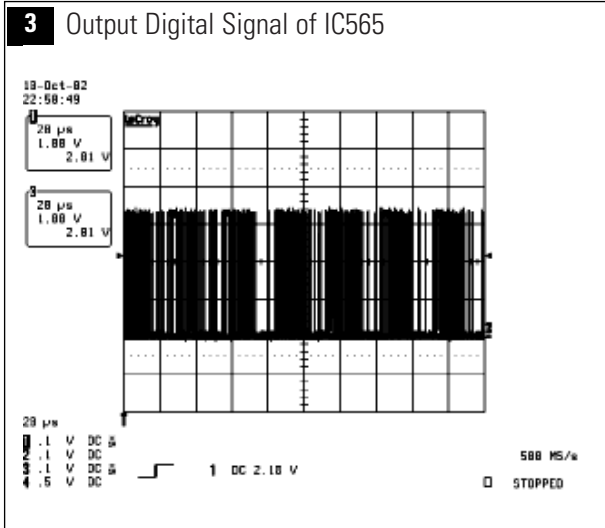

WAVEFORMS

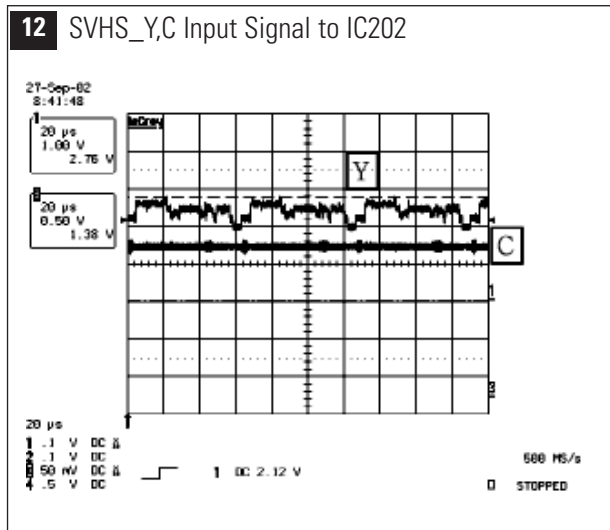
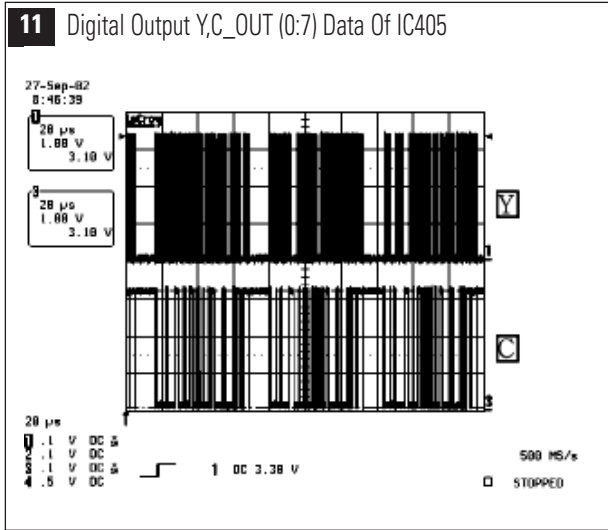
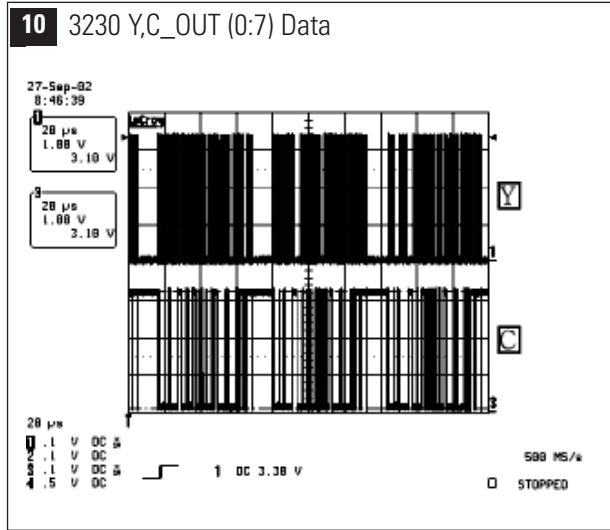

5-7 No Picture (Component1, 2 : 480i, 480p, 720p, 1080i [Y, Pb, Pr])

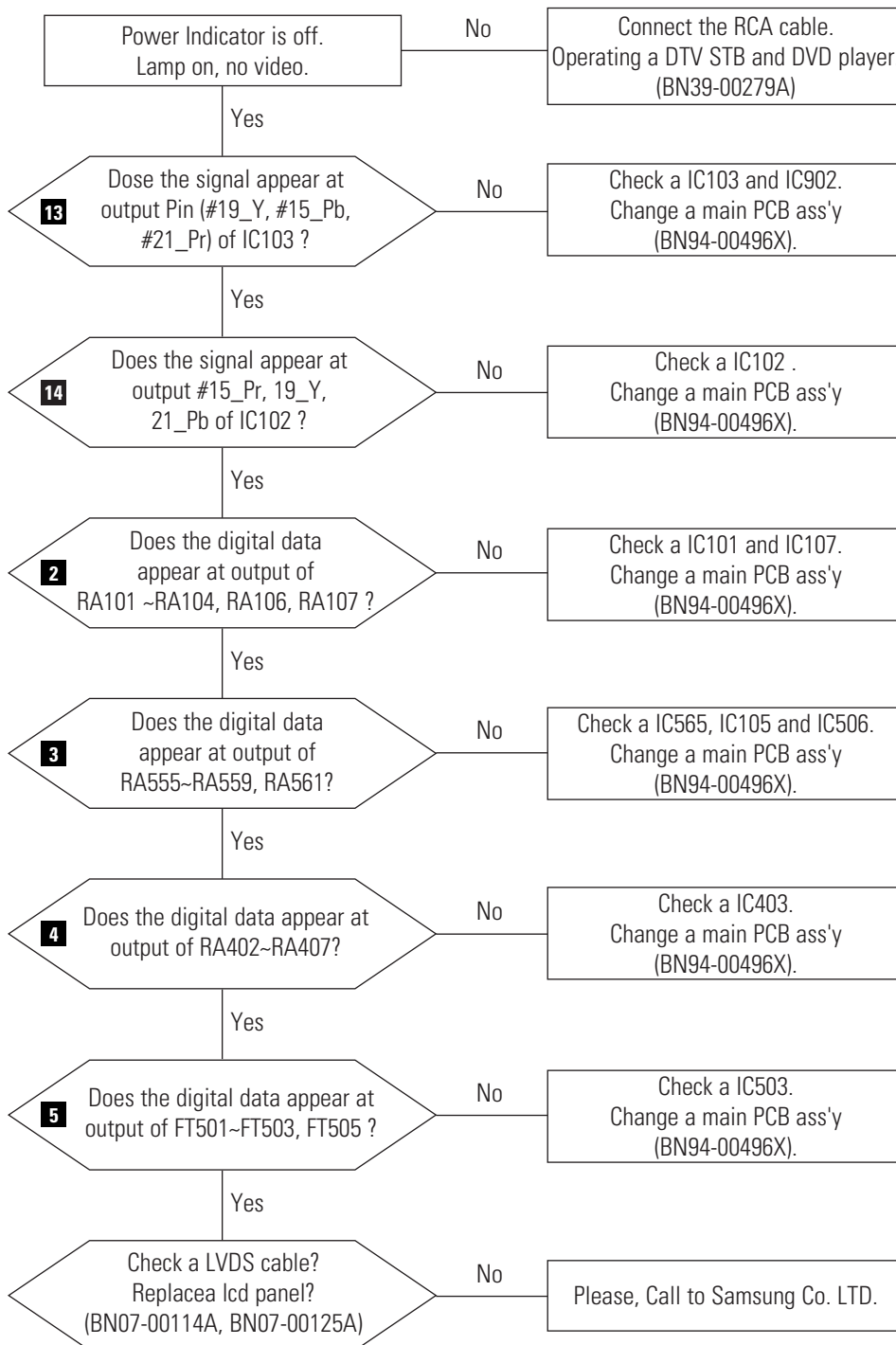

WAVEFORMS

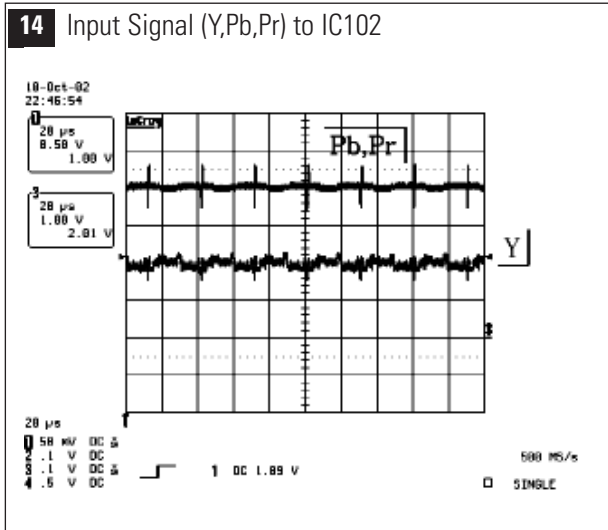
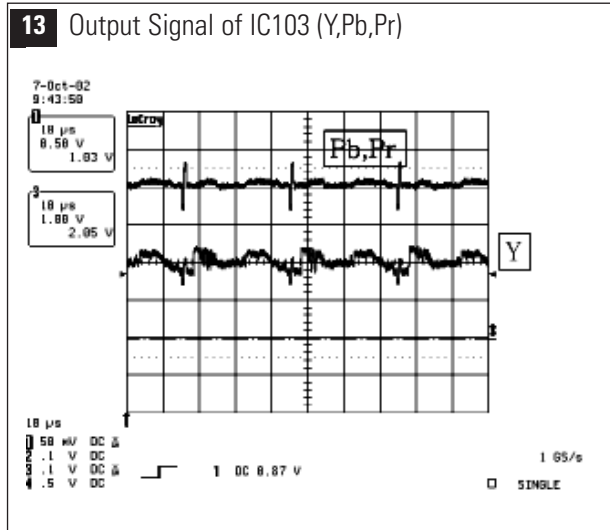
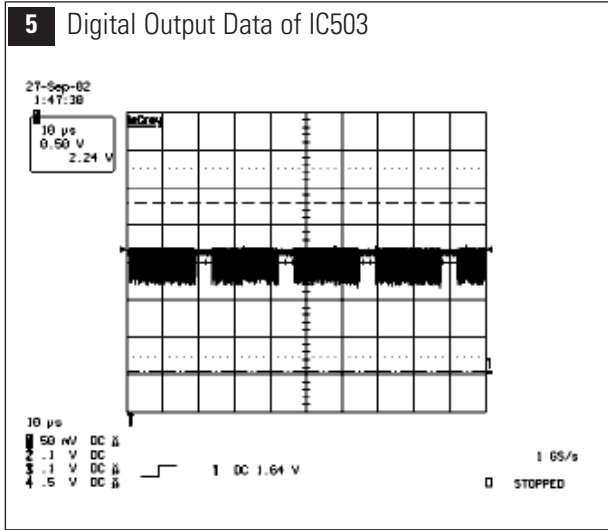
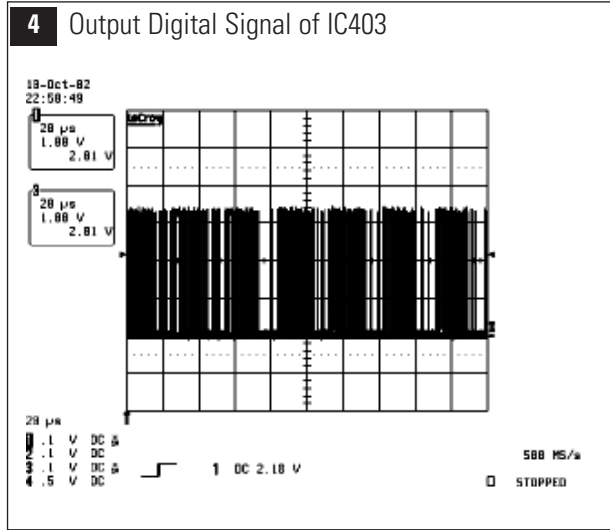
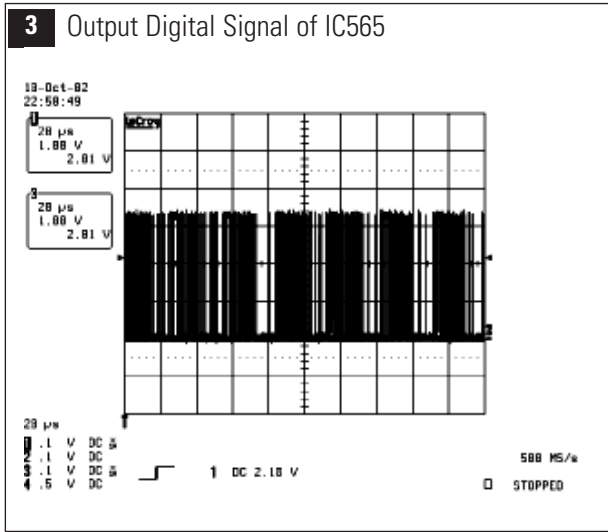
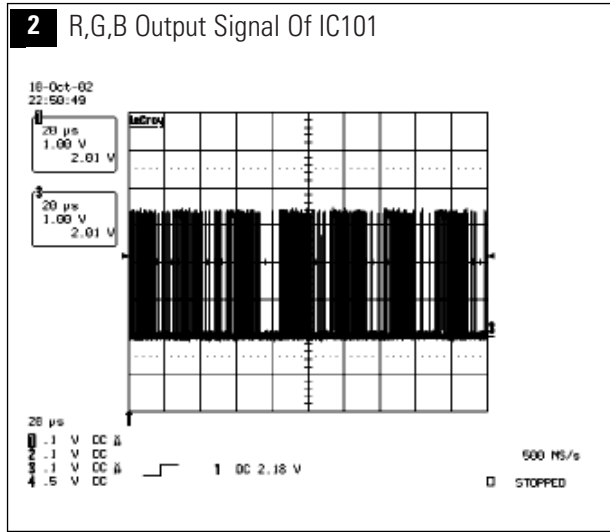

5-8 No Sound

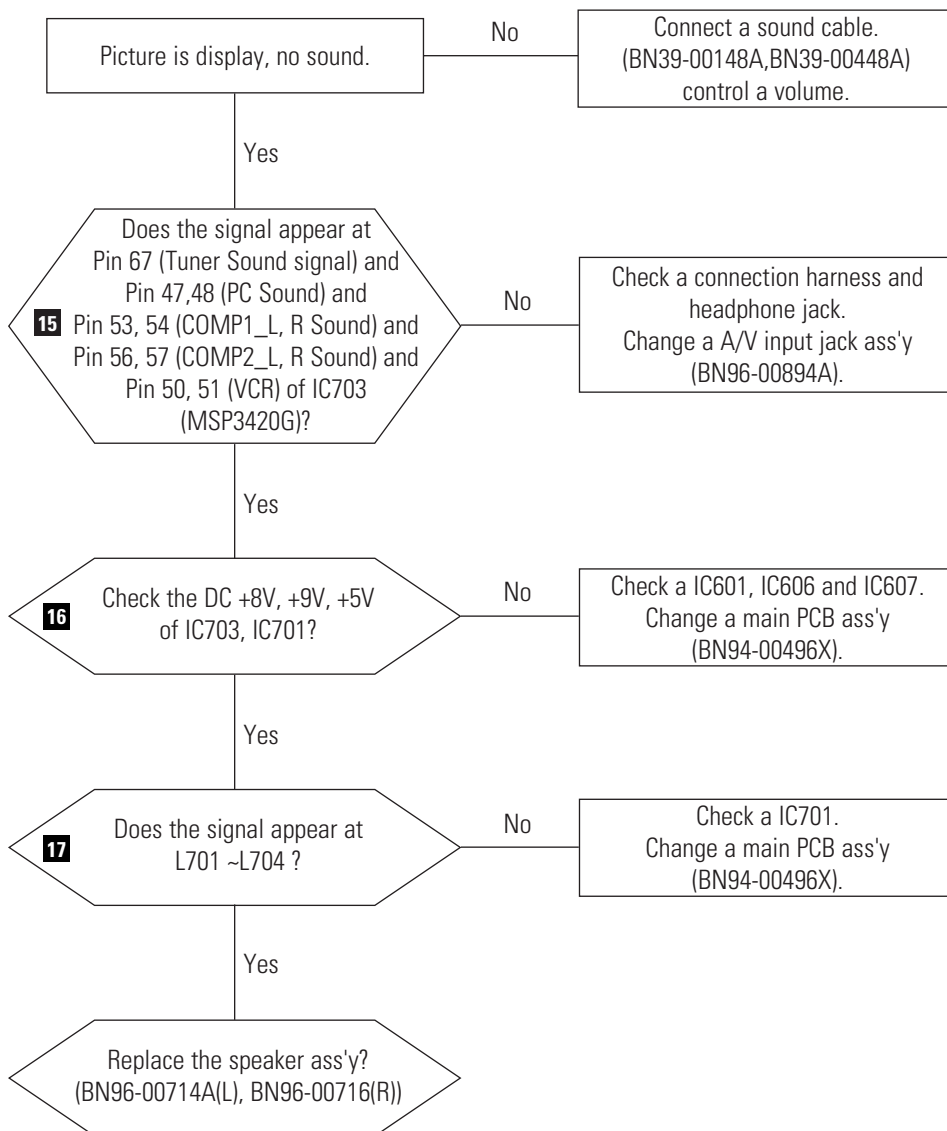

WAVEFORMS

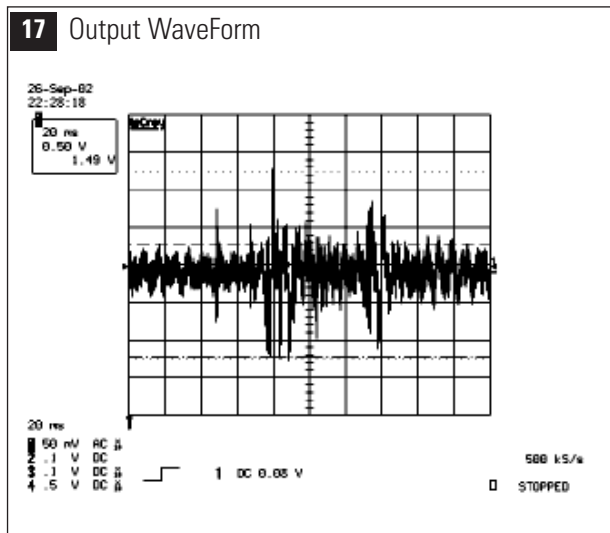
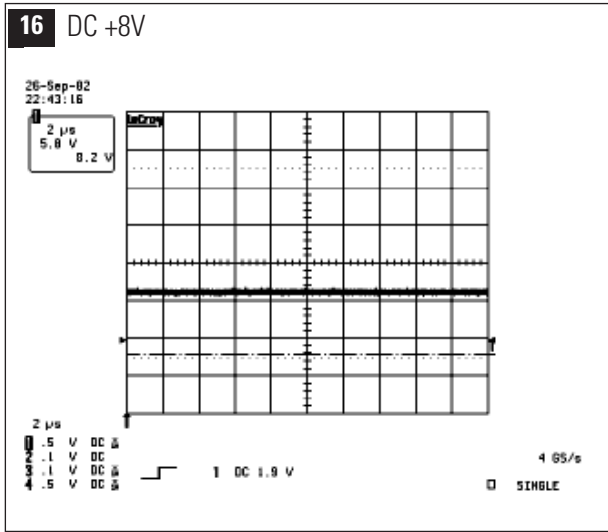
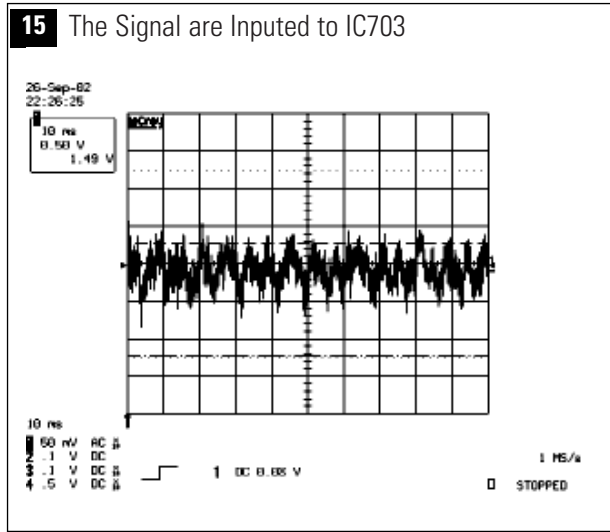

6 Exploded View and Parts List

* You can search for updated part codes through ITSELF web site.

URL : <http://itself.sec.samsung.co.kr/>

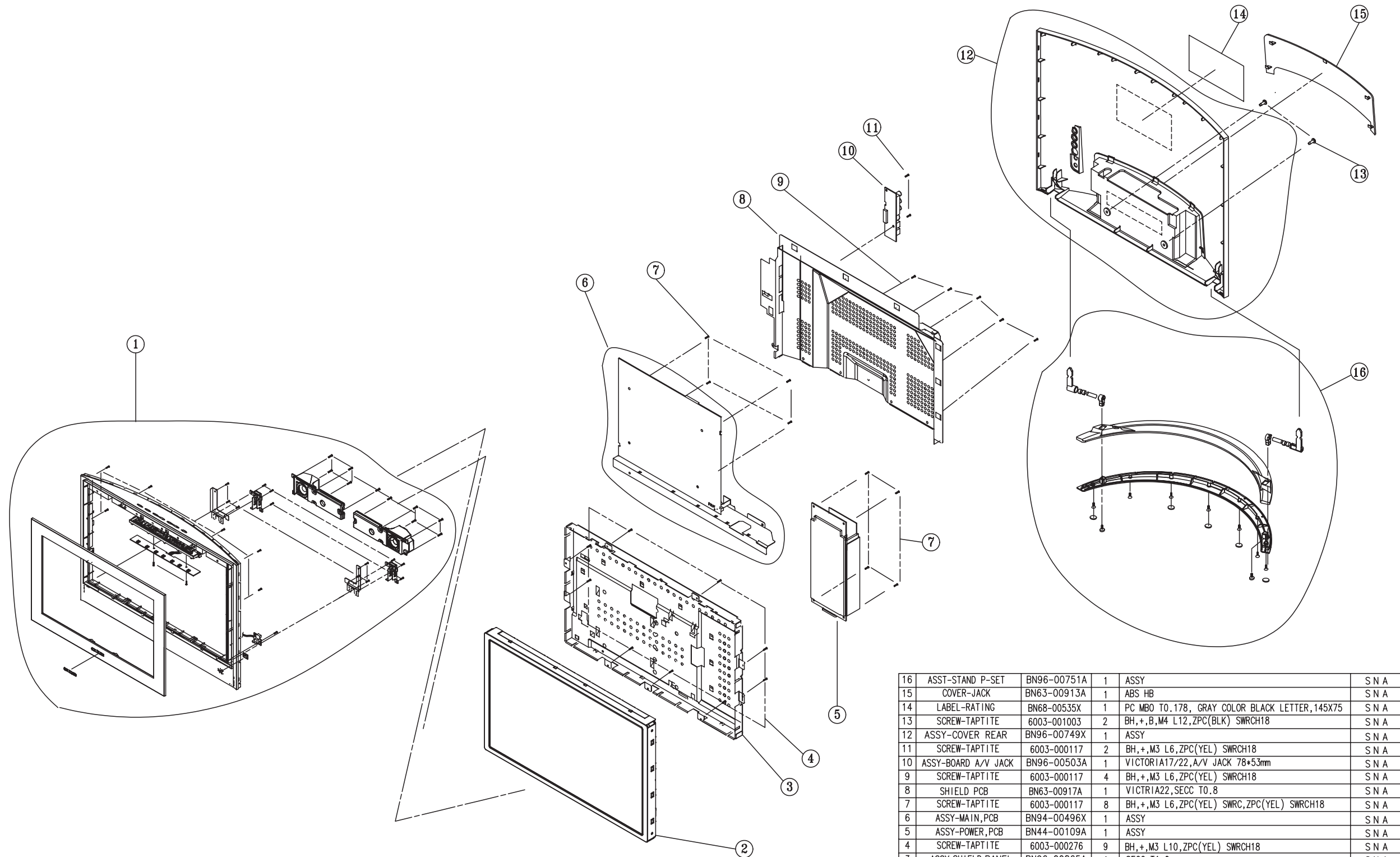

16	ASST-STAND P-SET	BN96-00751A	1	ASSY	S N A
15	COVER-JACK	BN63-00913A	1	ABS HB	S N A
14	LABEL-RATING	BN68-00535X	1	PC MBO T0.178, GRAY COLOR BLACK LETTER,145X75	S N A
13	SCREW-TAPTITE	6003-001003	2	BH,+,B,M4 L12,ZPC(BLK) SWRCH18	S N A
12	ASSY-COVER REAR	BN96-00749X	1	ASSY	S N A
11	SCREW-TAPTITE	6003-000117	2	BH,+,M3 L6,ZPC(YEL) SWRCH18	S N A
10	ASSY-BOARD A/V JACK	BN96-00503A	1	VICTORIA17/22,A/V JACK 78+53mm	S N A
9	SCREW-TAPTITE	6003-000117	4	BH,+,M3 L6,ZPC(YEL) SWRCH18	S N A
8	SHIELD PCB	BN63-00917A	1	VICTRIA22,SECC T0.8	S N A
7	SCREW-TAPTITE	6003-000117	8	BH,+,M3 L6,ZPC(YEL) SWRC,ZPC(YEL) SWRCH18	S N A
6	ASSY-MAIN,PCB	BN94-00496X	1	ASSY	S N A
5	ASSY-POWER,PCB	BN44-00109A	1	ASSY	S N A
4	SCREW-TAPTITE	6003-000276	9	BH,+,M3 L10,ZPC(YEL) SWRCH18	S N A
3	ASSY SHIELD PANEL	BN96-00865A	1	SECC T1.0	S N A
2	PANEL-SEC/TORISAN	BN07-00114A/125A	1	22 INCH	S N A
-	SPEAKER ASSY	BN96-0071A(L)/716A(R)	1	8 OHM, 5W	S N A
1	ASSY-COVER FRONT	BN96-00750X	1	ASSY	S N A
NO	PART NAME	CODE NO.	Q'TY	SPECIFICATION	REMARK

Memo

7 Parts List

* You can search for updated part codes through ITSELF web site.

URL : <http://itself.sec.samsung.co.kr/>

7-1 Part Lists

Description	Code No.
ASSY PCB MAIN	BN94 - 00496X
ASSY COVER FRONT	BN90 - 00620A
ASSY COVER REAR	BN90 - 00540A
LCD-PANEL	BN07 - 00125A
ASSY CHASSIS	BN91 - 00722C
ASSY SHIELD	BN91 - 00763A
ASSY BOARD P-AV/JACK	BN96 - 00894A
ASSY BOX	BN92 - 00888A
ASSY LABEL	BN92 - 00889A
REMOCON	BN59 - 00394B
ASSY ACCESSORY	BN92 - 00702H

<OPTION PART LIST>	
--------------------	--

IF Cable	: AA39-00039A
A/V Cable	: BN39-00057A
S-Video Cable	: BN39-00060A
COMPONENT Cable	: BN39-00279A
SOUND Cable(R, L)	: BN39-00148A
PC DVI(D) Cable	: BN39-00126A
PC DVI(A) Cable	: BN39-00310A
DVI AUDIO Cable	: BN81-00120A
STEREO Cable	: BN39-00448A

Memo

8 Block Diagram

* This Document can not be used without Samsung's authorization.

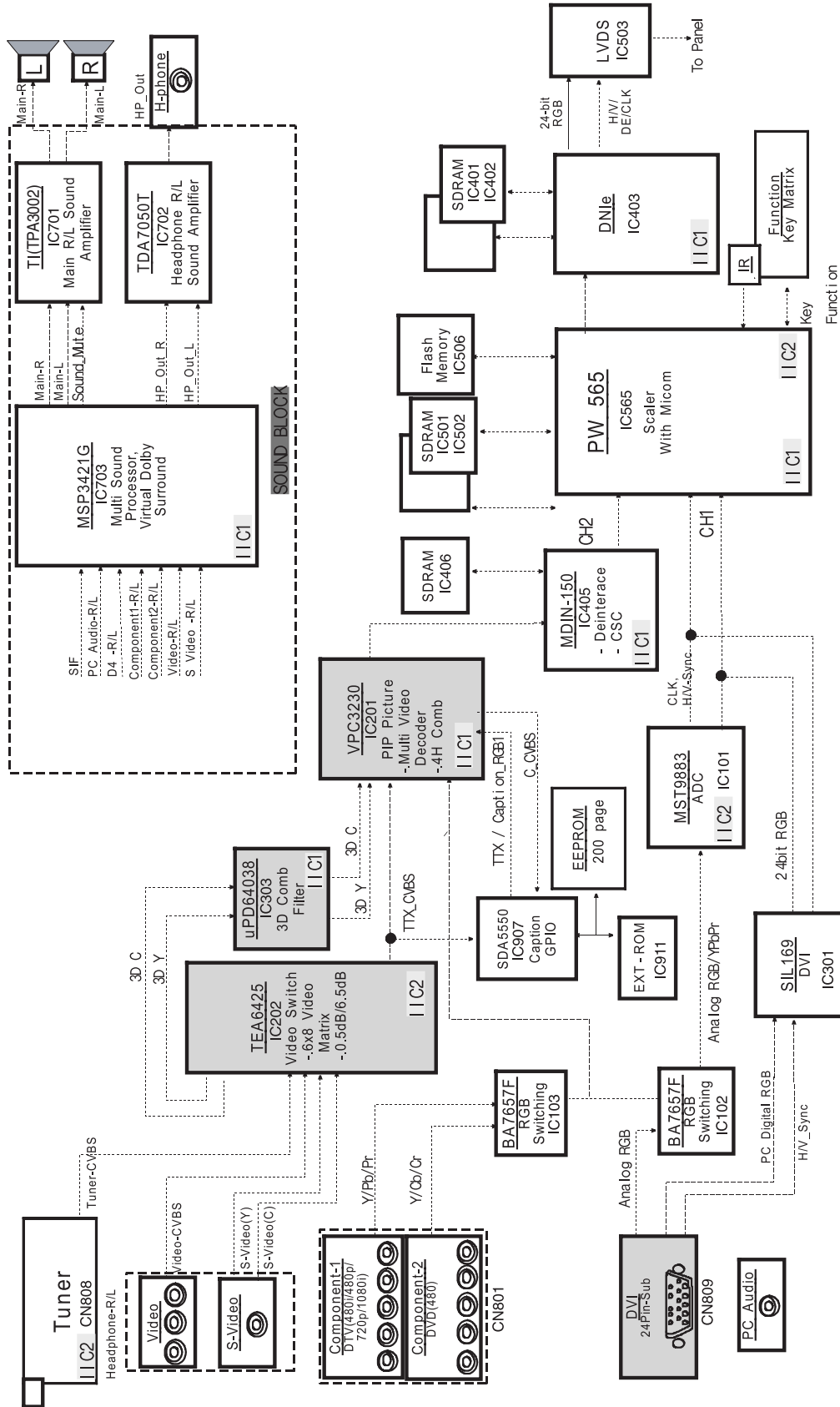

Memo

10 PCB Layout

10-1 Main PCB Layout

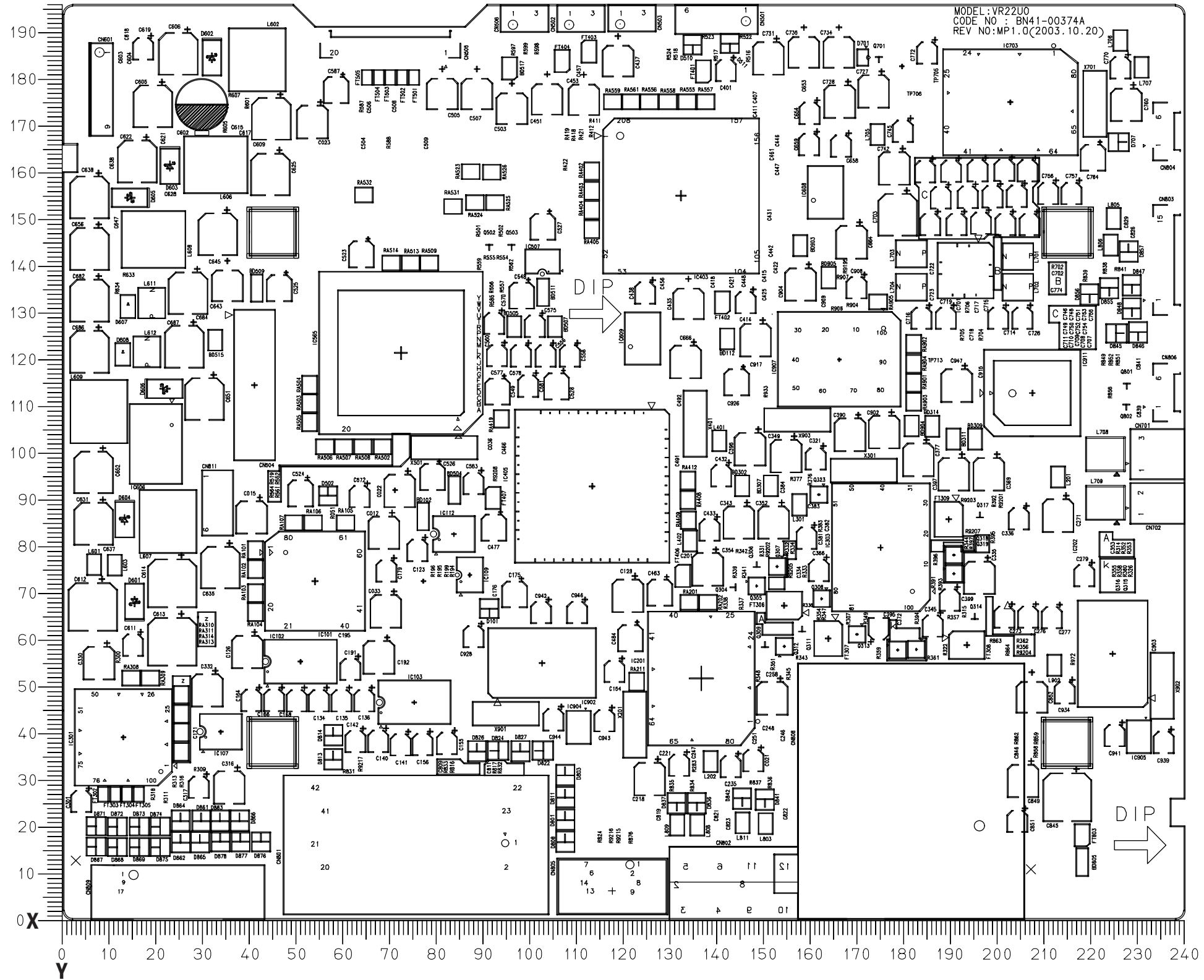

Loc. No.	Description	X	Y
DIODE			
D101	DIODE-ARRAY	91.2	66.9
D300	DIODE-ZENER	25.3	32.5
D324	DIODE-SWITCHING	176.6	98.0
D501	DIODE-ZENER	76.7	86.5
D502	DIODE-SWITCHING	56.6	91.3
D510	DIODE-SWITCHING	134.7	188.4
D511	DIODE-SWITCHING	142.7	188.7
D601	DIODE-RECTIFIER	15.2	68.5
D602	DIODE-RECTIFIER	31.8	185.7
D603	DIODE-RECTIFIER	22.8	162.3
D604	DIODE-RECTIFIER	13.1	86.1
D605	DIODE-RECTIFIER	14.2	155.5
D606	DIODE-RECTIFIER	21.7	114.3
D607	DIODE-SCHOTTKY	13.8	131.9
D608	DIODE-SCHOTTKY	12.7	121.6
D701	DIODE-ZENER	171.2	185.7
D702	DIODE-SWITCHING	173.3	178.6
D703	DIODE-ZENER	163.4	186.5
D704	DIODE-ZENER	155.6	186.9
D705	DIODE-ZENER	177.3	162.6
D706	DIODE-ZENER	221.5	185.8
D707	DIODE-ZENER	225.8	167.5
D801	DIODE-ZENER	107.4	21.4
D803	DIODE-ZENER	107.4	31.0
D805	DIODE-ZENER	47.8	21.1
D806	DIODE-ZENER	47.8	16.3
D808	DIODE-ZENER	107.4	16.6
D811	DIODE-ZENER	107.4	26.2
D813	DIODE-ZENER	60.0	33.2
D814	DIODE-ZENER	60.1	38.4
D815	DIODE-ZENER	235.1	179.3
D816	DIODE-ZENER	236.1	157.6
D817	DIODE-ZENER	230.6	174.5
D822	DIODE-ZENER	88.7	41.0
D824	DIODE-ZENER	78.8	41.0
D826	DIODE-ZENER	78.8	36.1
D827	DIODE-ZENER	88.7	36.1
D836	DIODE-ZENER	135.6	25.1
D837	DIODE-ZENER	131.3	25.1
D838	DIODE-ZENER	135.6	25.1
D839	DIODE-ZENER	131.3	25.1
D841	DIODE-ZENER	150.2	25.9

Loc. No.	Description	X	Y
D842	DIODE-ZENER	145.3	26.1
D843	DIODE-ZENER	150.2	25.9
D844	DIODE-ZENER	145.3	26.1
D845	DIODE-ZENER	225.3	126.3
D846	DIODE-ZENER	230.1	126.5
D847	DIODE-ZENER	228.7	136.7
D848	DIODE-ZENER	228.7	131.7
D849	DIODE-SWITCHING	231.2	148.4
D851	DIODE-ZENER	223.1	137.6
D852	DIODE-ZENER	224.8	150.9
D853	DIODE-ZENER	223.1	132.0
D854	DIODE-ZENER	224.8	145.3
D855	DIODE-ZENER	223.9	136.1
D856	DIODE-ZENER	219.7	134.7
D857	DIODE-ZENER	228.0	143.8
D858	DIODE-ZENER	230.6	163.4
D859	DIODE-ZENER	230.2	179.2
D861	DIODE-ZENER	29.5	21.2
D862	DIODE-ZENER	25.1	16.5
D863	DIODE-ZENER	33.5	21.2
D864	DIODE-ZENER	25.1	21.2
D865	DIODE-ZENER	29.2	16.5
D866	DIODE-ZENER	37.7	21.2
D867	DIODE-SWITCHING	7.0	15.6
D868	DIODE-SWITCHING	11.5	15.5
D869	DIODE-SWITCHING	16.2	15.5
D871	DIODE-SWITCHING	7.0	20.0
D872	DIODE-SWITCHING	11.5	19.9
D873	DIODE-SWITCHING	16.2	20.0
D874	DIODE-SWITCHING	20.7	20.0
D875	DIODE-SWITCHING	20.7	15.5
D876	DIODE-SWITCHING	42.3	16.7
D877	DIODE-SWITCHING	37.9	16.7
D878	DIODE-SWITCHING	33.6	16.7
D901	DIODE-SWITCHING	206.8	59.6
D906	DIODE-ZENER	152.7	127.8
D907	DIODE-ZENER	159.5	125.1
IC			
IC101	IC-A/D CONVERTER	53.9	72.9
IC102	IC-VIDEO SWITCH	54.5	55.4
IC103	IC-VIDEO SWITCH	107.9	69.2

Loc. No.	Description	X	Y
IC104	IC-POSI.FIXED REG.	65.1	58.8
IC105	IC-ANALOG SWITCH	37.7	56.4
IC107	IC-CMOS LOGIC	33.7	40.4
IC108	IC-EEPROM	97.1	70.2
IC109	IC-EEPROM	87.0	74.2
IC111	IC-ANALOG SWITCH	77.1	72.9
IC112	IC-ANALOG SWITCH	83.6	83.0
IC201	IC-VIDEO PROCESS	136.6	51.9
IC202	IC-VIDEO SWITCH	106.0	42.9
IC301	IC-RECEIVER	12.9	39.2
IC302	IC-VOL. DETECTOR	32.1	33.7
IC303	IC-SEPARATOR	176.6	76.2
IC401	IC-DRAM	147.6	168.4
IC402	IC-DRAM	147.9	144.6
IC403	IC-DISPLAY DRIVER	132.2	155.9
IC405	IC-VIDEO PROCESS	113.2	93.3
IC406	IC-DRAM	97.1	97.0
IC501	IC-DRAM	89.4	155.8
IC502	IC-DRAM	65.1	155.8
IC503	IC-TRANSMITTER	69.7	173.6
IC504	IC-VOL. DETECTOR	58.0	95.0
IC505	IC-CMOS LOGIC	71.0	92.5
IC506	IC-FLASH MEMORY	40.4	113.5
IC507	IC-EEPROM	102.6	141.7
IC565	IC-LCD CONTROLLER	72.3	122.0
IC601	IC-SWITCH VOL. REG.	32.1	186.8
IC602	IC-SWITCH REG.	14.5	68.1
IC603	IC-SWITCH VOL. REG.	22.2	162.4
IC604	IC-DC/DC CONVERTER	12.8	86.3
IC605	IC-SWITCH VOL. REG.	12.3	153.0
IC606	IC-DC/DC CONVERTER	19.8	101.9
IC607	FET-SILICON	162.7	172.7
IC608	IC-POSI.FIXED REG.	163.1	157.1
IC609	IC-POSI.FIXED REG.	124.0	125.6
IC611	IC-DC/DC CONVERTER	13.2	133.2
IC612	IC-DC/DC CONVERTER	10.5	121.8
IC701	IC-AUDIO AMP	193.1	139.8
IC702	IC-AUDIO AMP	179.5	183.8
IC703	IC-SOUND PROCESSOR	202.7	176.1
IC902	IC MICOM	209.1	81.5
IC903	IC MICOM	226.2	57.2
IC904	IC-VOL. DETECTOR	208.6	66.0
IC907	IC-DECODER	166.1	120.6

Loc. No.	Description	X	Y
IC911	IC-EEPROM	207.5	103.1
IC915	IC-EEPROM	148.2	121.9
TRANSISTOR			
Q101	TR-SMALL SIGNAL	78.3	66.6
Q102	TR-SMALL SIGNAL	85.1	81.7
Q301	TR-SMALL SIGNAL	182.3	89.0
Q302	TR-SMALL SIGNAL	186.4	88.6
Q303	TR-SMALL SIGNAL	182.1	89.2
Q304	TR-SMALL SIGNAL	161.5	98.6
Q305	TR-SMALL SIGNAL	157.3	97.1
Q306	TR-SMALL SIGNAL	161.5	102.7
Q307	TR-SMALL SIGNAL	157.2	101.4
Q308	TR-SMALL SIGNAL	172.3	89.9
Q309	TR-SMALL SIGNAL	154.9	87.1
Q311	TR-SMALL SIGNAL	161.2	92.4
Q312	TR-SMALL SIGNAL	157.2	91.6
Q313	TR-SMALL SIGNAL	159.5	84.9
Q314	TR-SMALL SIGNAL	148.6	82.6
Q315	TR-SMALL SIGNAL	150.1	78.2
Q316	TR-SMALL SIGNAL	156.5	80.6
Q317	TR-SMALL SIGNAL	160.2	61.5
Q318	TR-SMALL SIGNAL	150.4	67.7
Q319	TR-SMALL SIGNAL	157.2	69.3
Q323	TR-SMALL SIGNAL	190.5	89.0
Q324	FET-SILICON	25.5	27.5
Q325	FET-SILICON	21.4	27.4
Q502	FET-SILICON	91.1	145.3
Q503	FET-SILICON	96.0	145.3
Q504	FET-SILICON	70.5	81.2
Q505	FET-SILICON	64.6	81.3
Q601	TR-SMALL SIGNAL	21.0	98.4
Q602	TR-SMALL SIGNAL	171.0	163.9
Q603	TR-SMALL SIGNAL	172.9	170.0
Q701	TR-SMALL SIGNAL	174.6	185.8
Q702	TR-SMALL SIGNAL	199.5	130.0
Q703	TR-SMALL SIGNAL	186.6	129.2
Q801	TR-SMALL SIGNAL	227.6	115.4
Q802	TR-SMALL SIGNAL	227.5	110.9
Q901	TR-SMALL SIGNAL	157.7	135.7
Q903	TR-SMALL SIGNAL	148.7	111.4

9 Wiring Diagram

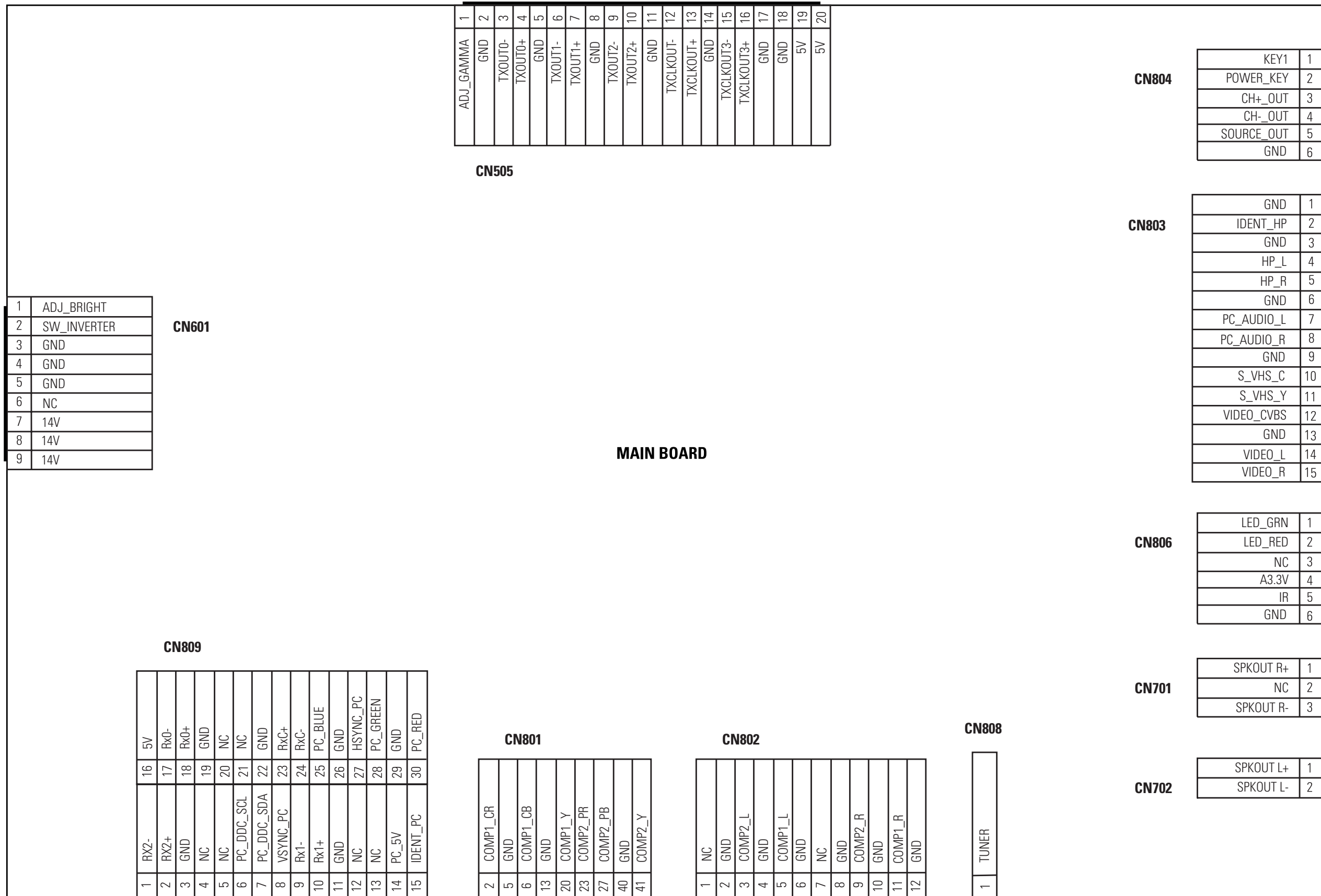

Memo

11 Schematic Diagrams

* This Document can not be used without Samsung's authorization.

11-1 Schematic Diagram

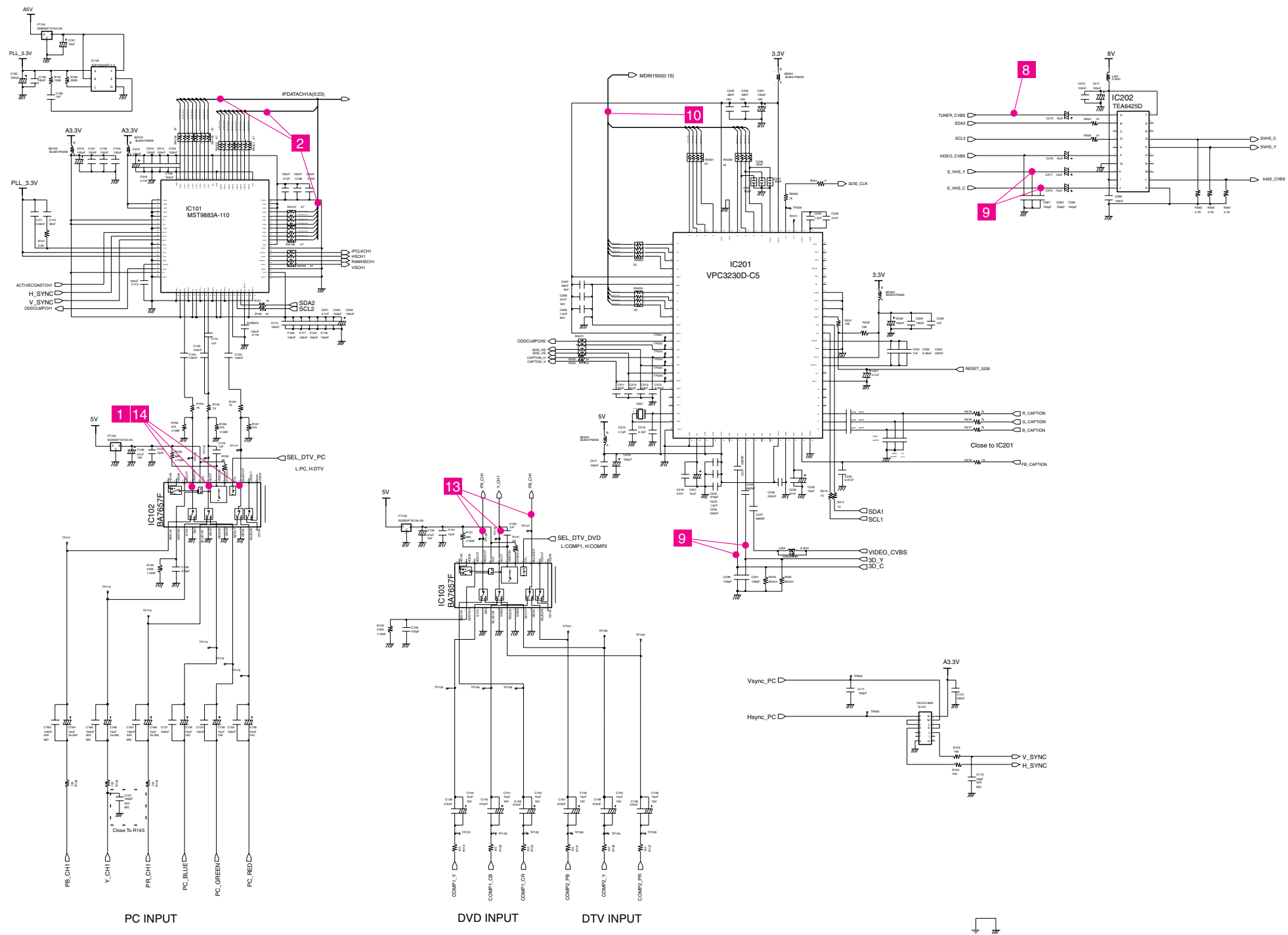

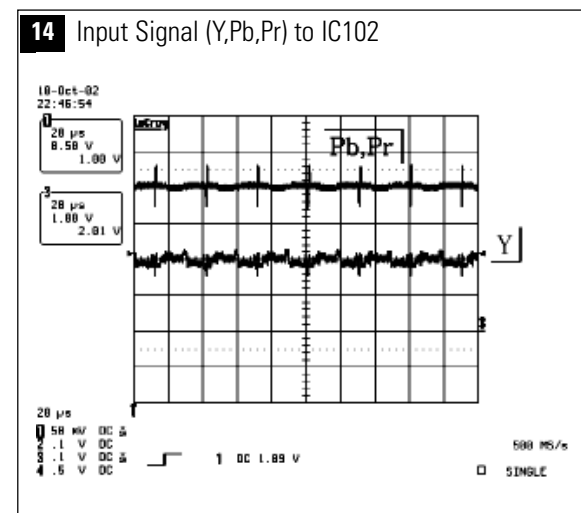
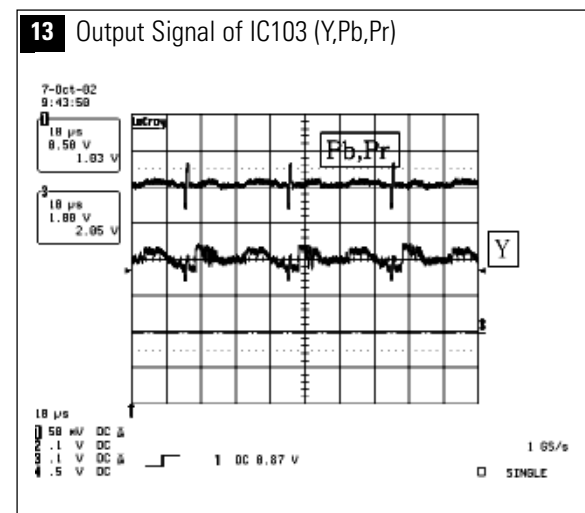
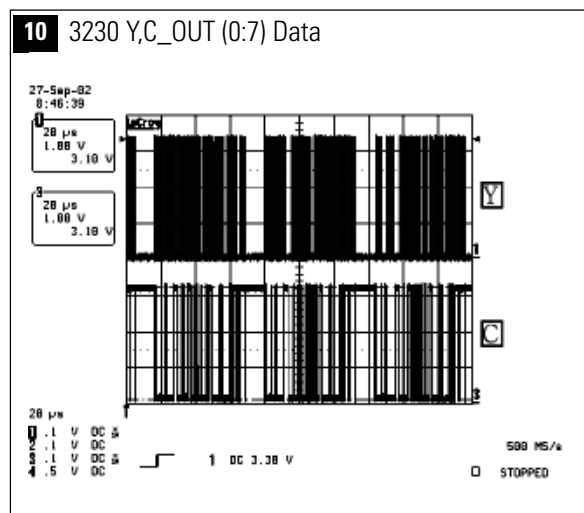
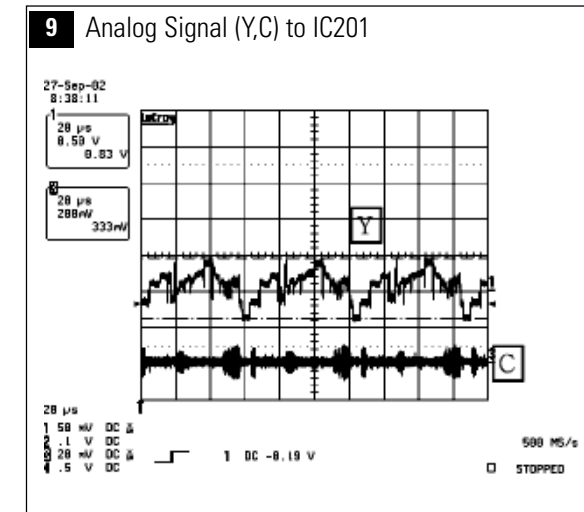
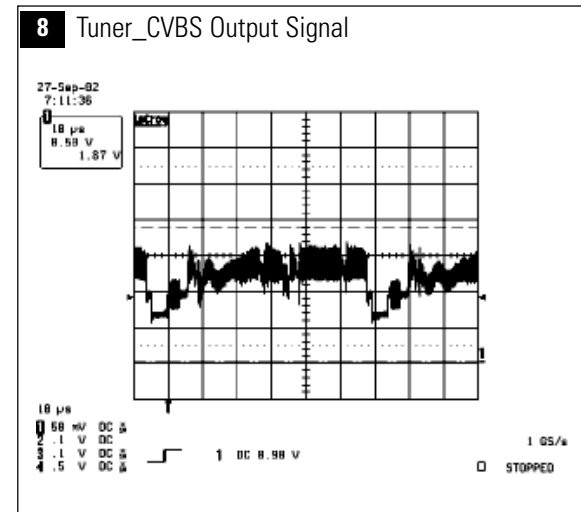
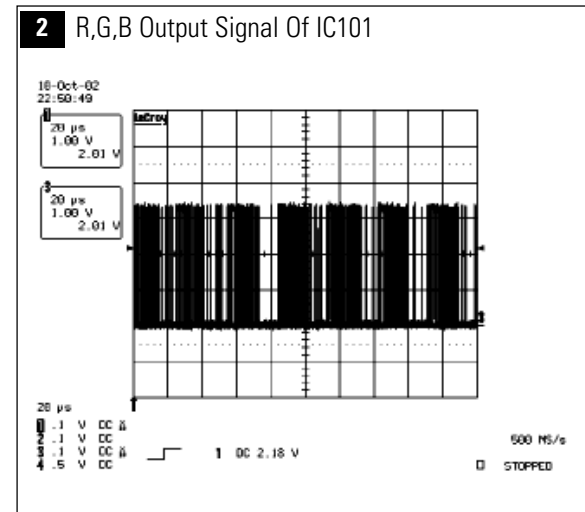
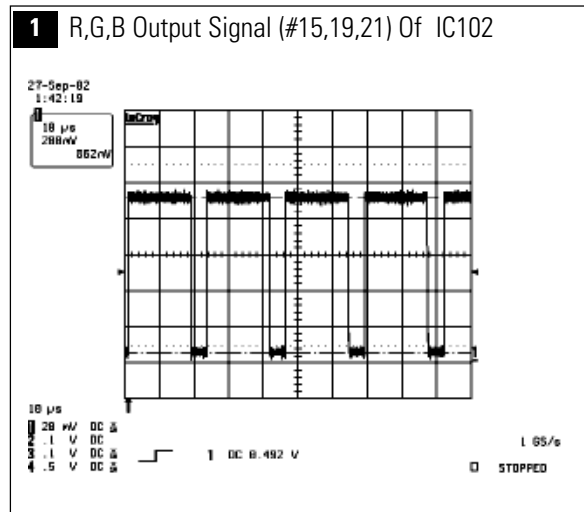

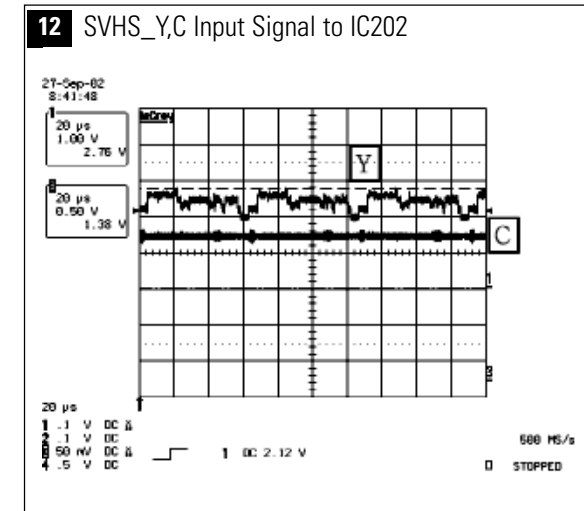
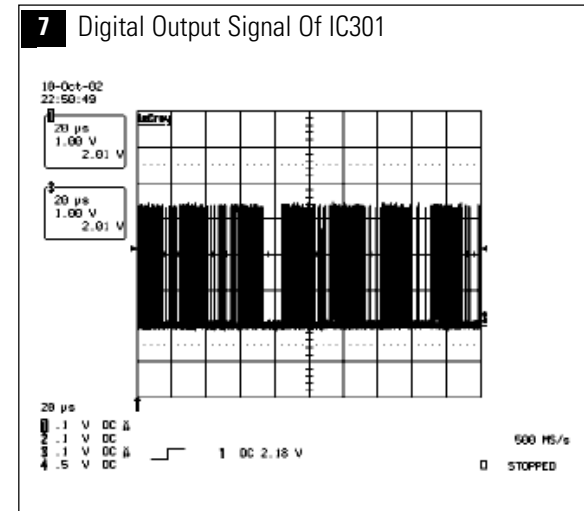
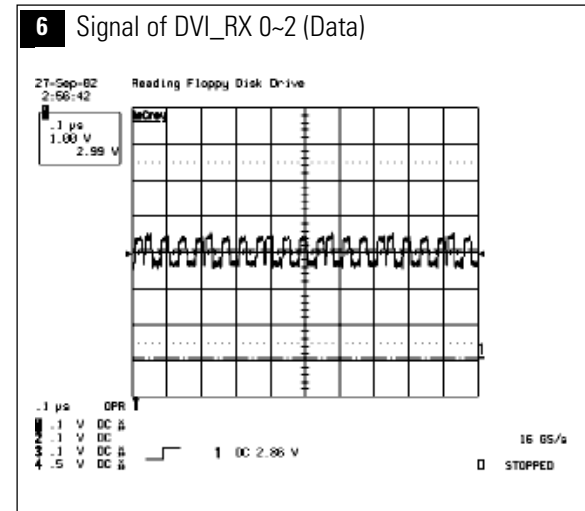
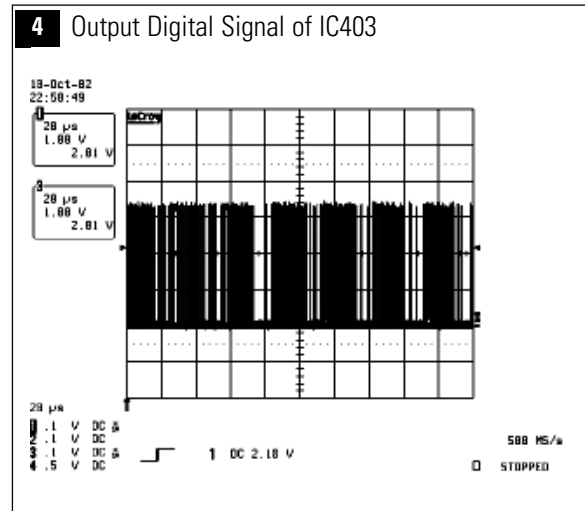

* This Document can not be used without Samsung's authorization.

11-3 Schematic Diagram

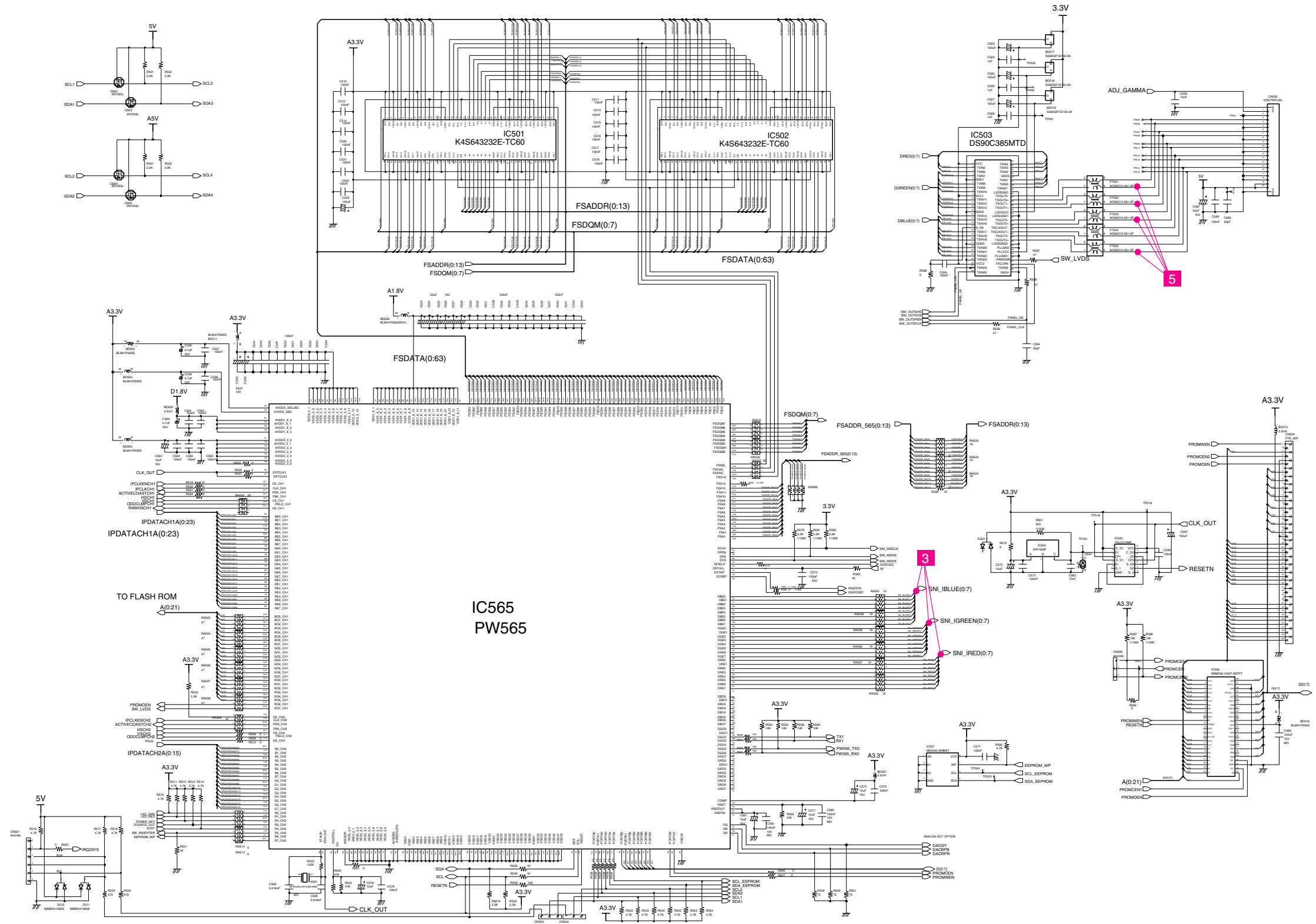

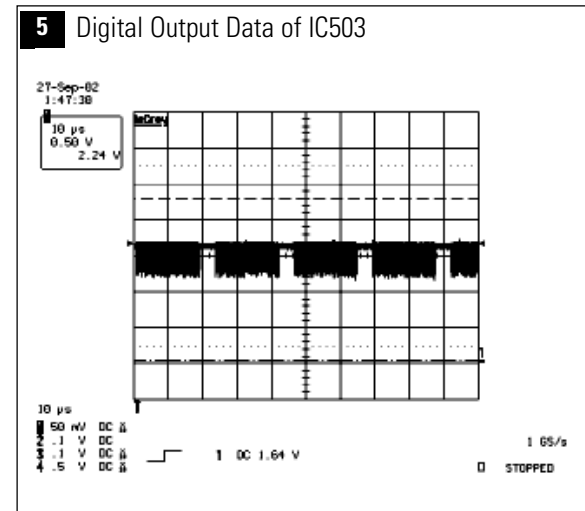
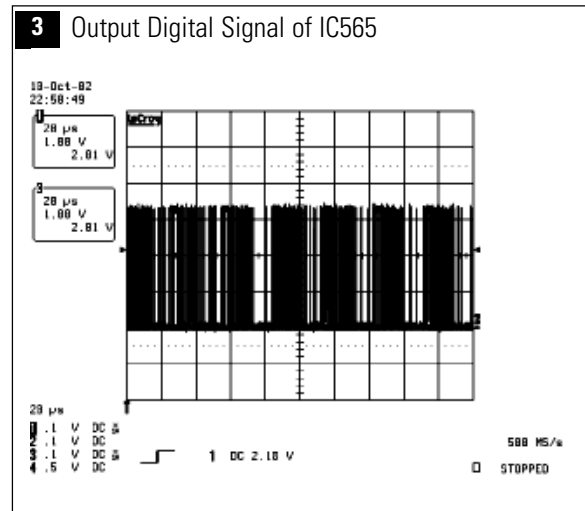

* This Document can not be used without Samsung's authorization.

11-4 Schematic Diagram

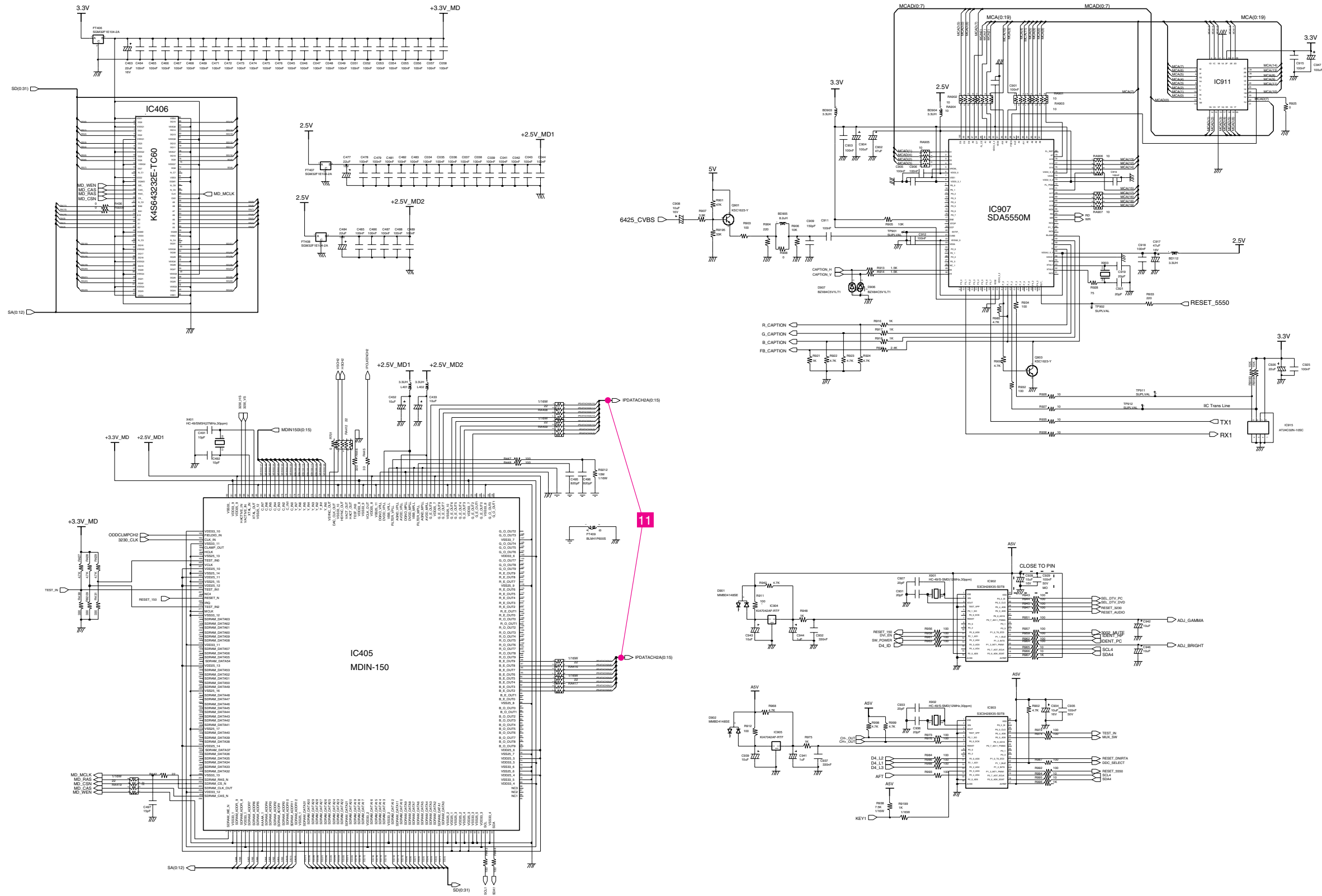

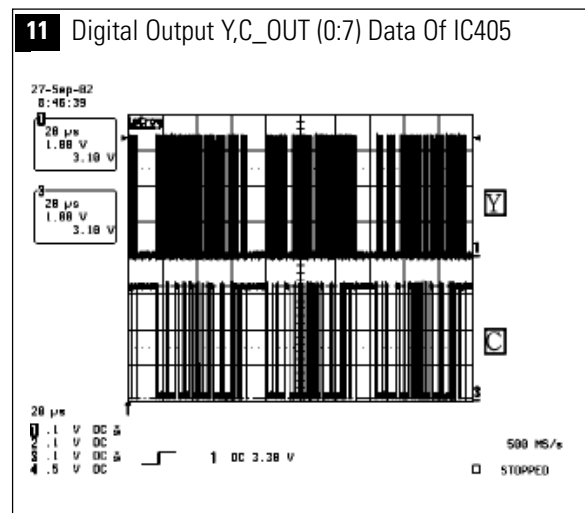

* This Document can not be used without Samsung's authorization.

11-5 Schematic Diagram

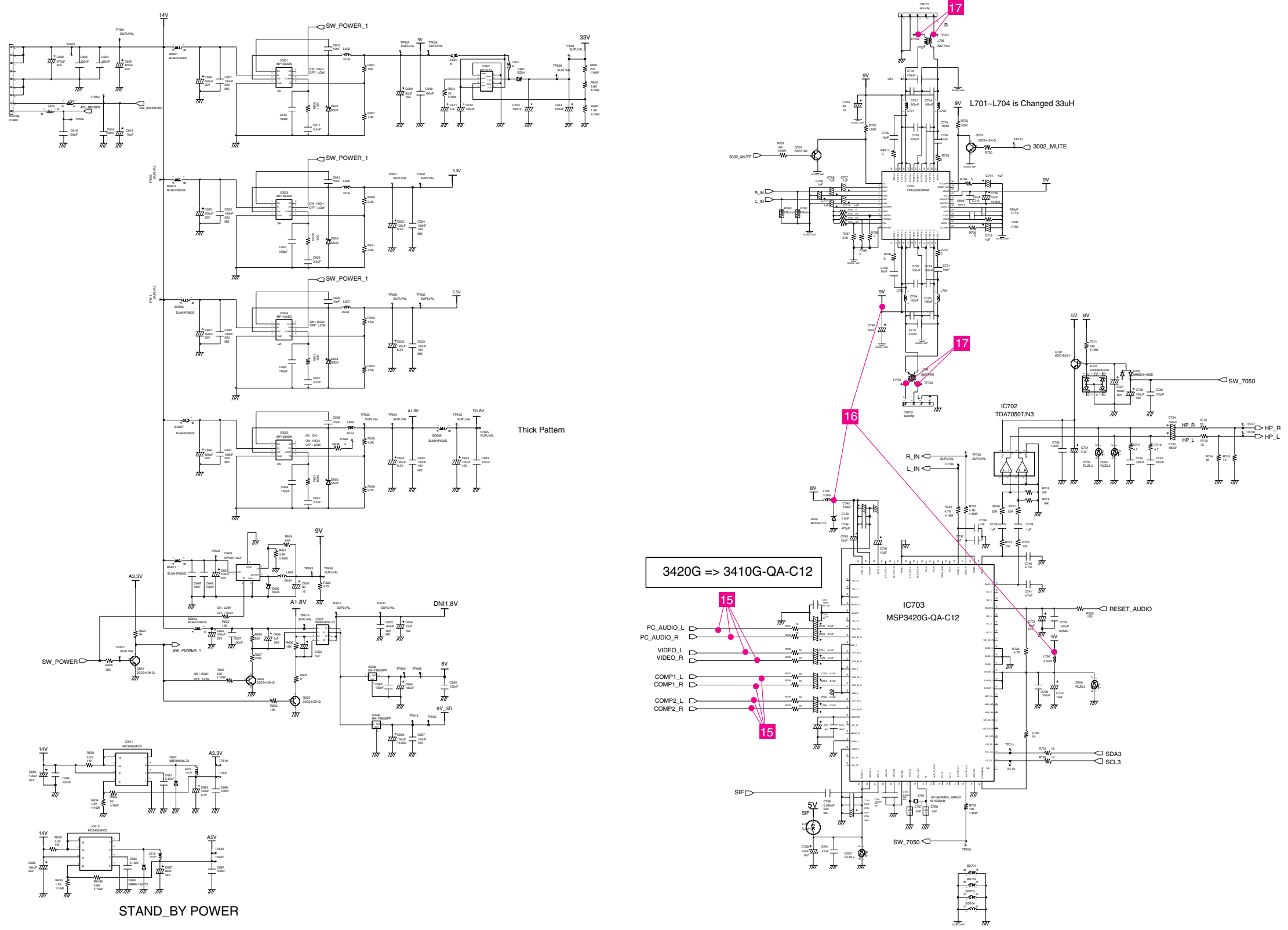

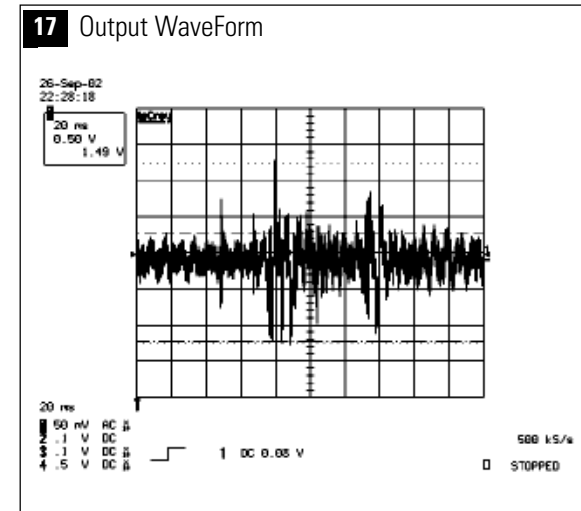
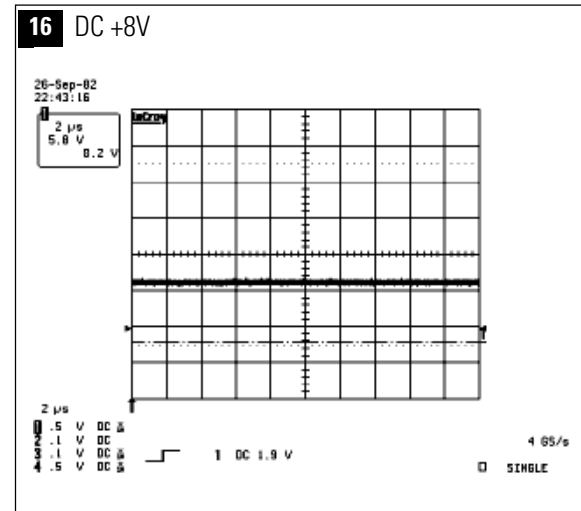
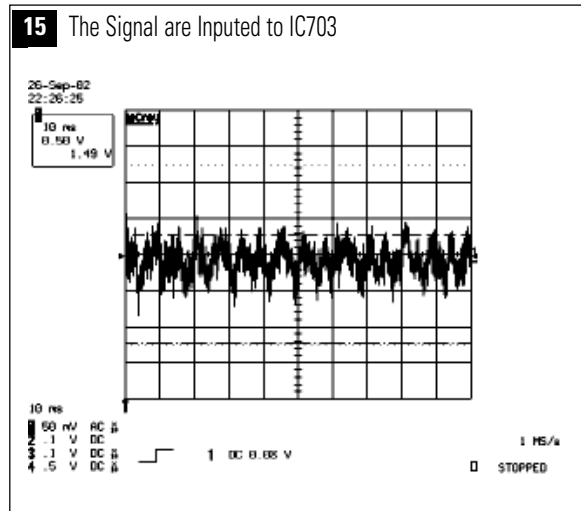

* This Document can not be used without Samsung's authorization.

11-6 Schematic Diagram

COMPONENT_1,2_VIDEO_INPUT

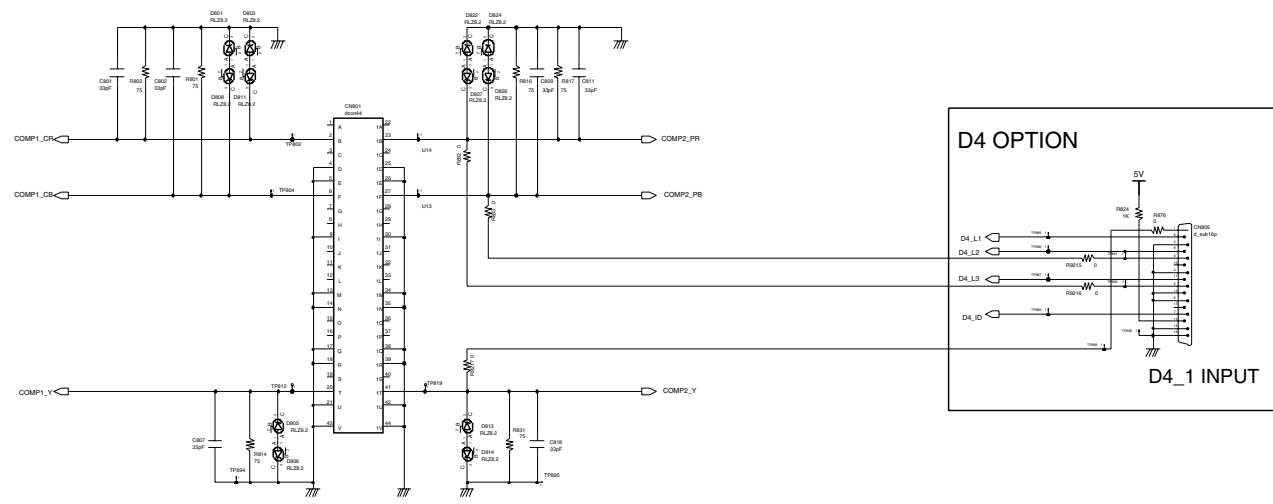

CHANGE TO(3722-001810)

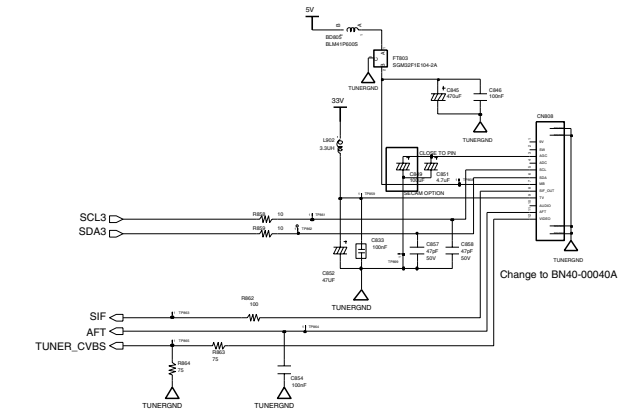

DVI / PC INPUT

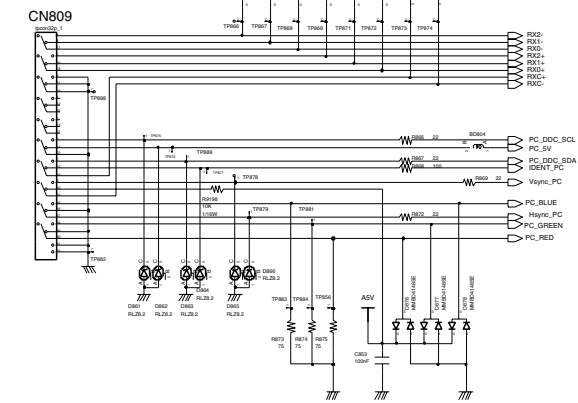

COMPONENT1 AUDIO INPUT

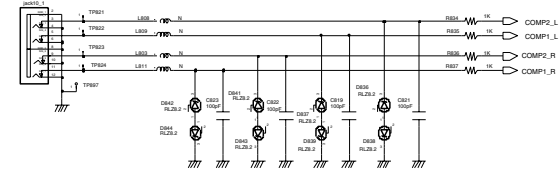

COMPONENT2 & D4 AUDIO INPUT

FROM SUB INPUT BOARD

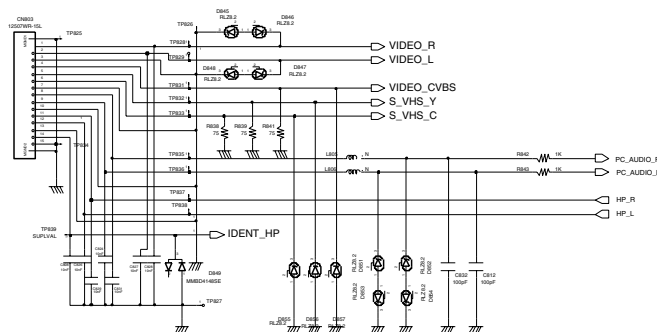

FUNCTION BOARD

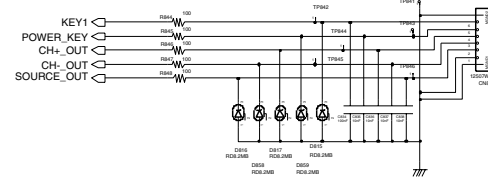

FROM REMUTE/CON BOARD

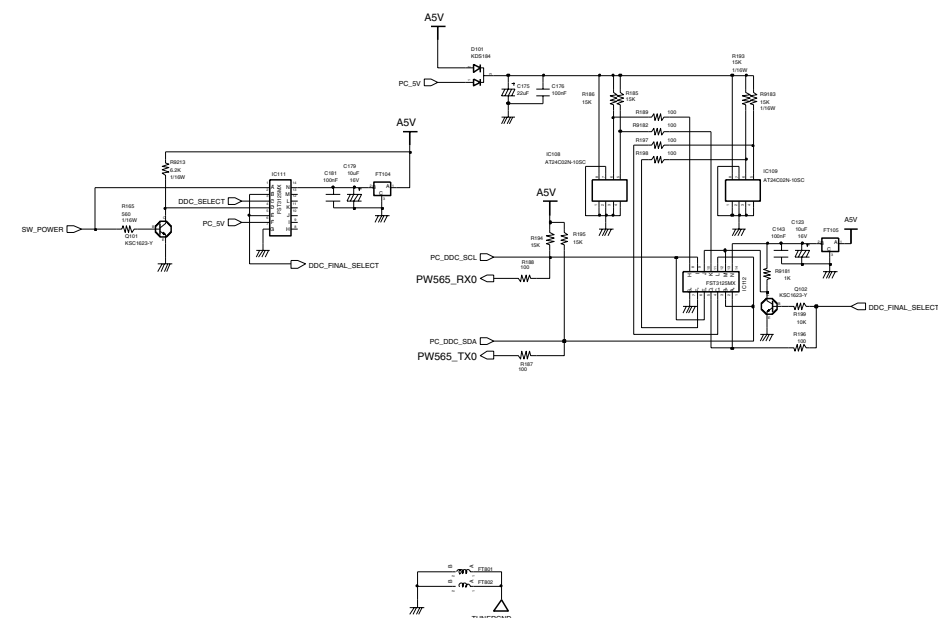
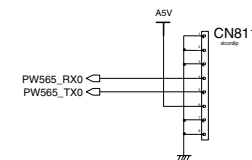
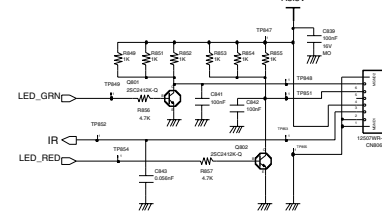

Memo